

CONTENTS

1	INTRODUCTION		2
1.1	About the operating manual		2
1.2	DEFAAS		2
2	DEFA WarmUp		3
2.1	General information		3
2.2	Environment		4
2.3	Safety		8
2.4	Economy		8
2.5	Comfort		8
2.7	Timer	- SmartStart™/Futura	9
2.8	Engine heater	- SafeStart	16
2.9	Interior heater	- Termini™/Termina	20
2.10	Battery charger	- MultiCharger	22
2.11	Connection accessories	- MiniPlug/EcoPlug	23
3	INSTALLATION		24
3.1	General information		24
3.2	000-100 series	- SafeStart	31
3.3	200 series	- SafeStart	31
3.4	300 series	- SafeStart	32
3.5	400 series	- SafeStart	32
3.6	500 series	- SafeStart	33
3.7	600 series	- SafeStart	33
3.8	700 series	- SafeStart	34
3.9	800 series	- SafeStart	35
3.10	Feed through in the vehicle interior		36
3.11	Interior heater	- Termini™ / Termina	37
3.12	Battery charger	- MultiCharger	39
3.13	Timer	- SmartStart™ / Futura	41
3.14	Connection accessories		44
3.15	Circuit diagram	- WUP	47
4	SUPPORT		50
4.1	Engine heater	- SafeStart	50
4.2	Interior heater	- Termini™/Termina	52
4.3	Battery charger	- MultiCharger	52
4.4	Timer	- SmartStart™/Futura	53
4.5	Cables/contacts		54
4.6	Complaints procedure		55
4.7	Documentation	- CE/ISO/TS	56
4.8	DEFA Web	- www.defa.com	58

DEFAAS reserves the right to update and/or change our products and our products technical specification. Any printing errors and omission excepted.



DEFA WarmUp - In harmony with the environment



1 - INTRODUCTION



1.1 PURPOSE & SCOPE OF THE MANUAL

This manual is intended to serve as a reference for installers and other technical personnel who work with DEFA WarmUp. It provides answers to frequently asked questions about the benefits of using DEFA WarmUp. The manual also contains a general description of the installation of DEFA WarmUp and a basic troubleshooting guide. Important information contained in the manual is indicated as follows:



Specify important information and practical tips for the use or installation of DEFA WarmUp.

1.2 DEFA AS

DEFA AS is a private company located in Norway, and it was founded in 1946. DEFA is a modern operation with about 350 employees, who have mastered a broad spectrum of different technologies including aluminium die casting, plastic injection moulding, automated cable handling and programming of microprocessors and integrated circuits. More than 80% of our turnover is derived from exports. The company is headquartered in Nesbyen/Hallingdal, administration and marketing are based in Sandvika, which is close to Oslo. Production is primarily conducted in the company's own facilities in Norway, Sweden and China. DEFA's facilities are certified to ISO 9001 and ISO 14001. In addition to this, our engine heaters and cables are conforming to the requirements of ISO/TS 16949:2002.

DEFA is a market oriented company with cooperation partners who offer a high level of expertise in marketing, sales and distribution.

DEFA is a leading supplier of electrical vehicle heating systems in Europe.

Business concept and objectives

Our strategy is clear. Innovative research and development in the high-tech sector is key in maintaining our leading position in the market. Our cooperation partners in the import/distribution chain shall support us with direct marketing activities for consumers.

Product groups

DEFA is the market leader in niche product groups: vehicle heating systems (DEFA WarmUp), alarm systems for vehicles (DEFA Auto Security) and boats (DEFA Boat Security), vehicle tracking systems (DEFA Tracking), remote control and monitoring of home and/or holiday home water and heating systems (DEFA HomeSecurity), outdoor electric power outlets (DEFA Electric Outlet) and indoor/outdoor lighting systems (DEFA Lighting).

DEFA WarmUp



Comfortably warm car > ice-free windows > less exhaust fumes
Less engine wear > lower fuel consumption

2 - DEFA WarmUp



2.1 GENERAL INFORMATION

DEFA WarmUp is what is commonly referred to as a complete vehicle heating system. DEFA WarmUp consists of a battery charger, interior heater, time-program controller, vehicle-specific engine heater and cables and junctions to connect the system. We have our own special designations for these components:

Timer	=	SmartStart™ / Futura
Battery charger	=	MultiCharger
Interior heater	=	Termini™ / Termina
Engine heater	=	SafeStart
Connection cables	=	GreenLink

DEFA WarmUp ensures that a passenger car will be warm and ready-to-start, and provides the same level of comfort that a vehicle can normally only provide after having been driven several kilometres. DEFA WarmUp offers a convenient, reliable and effective means of providing passenger car drivers with a warm and comfortable interior for improved safety and reduced environmental impact.

DEFA WarmUp is a simple, user-friendly system, which is controlled with the SmartStart™ remote controlled timer or the permanently mounted Futura timer. At the touch of a few buttons, the vehicle owner can ensure reliable starting of the engine, a comfortable climate in the interior of the vehicle, ice-free windows and a fully charged battery – in any conditions and throughout the winter.

Environmentally-friendly vehicles are becoming increasingly more important for manufacturers and vehicle owners alike, especially because legislators such as the EU, for example, are enacting ever stricter directives for maximum permissible emissions from combustion engines. Regardless of how modern it may be, a cold engine produces more exhaust fumes and burns more fuel. Only a warm engine can heat-up the catalytic converter quickly, and thus significantly reduce exhaust fumes. Moreover, a warm motor burns substantially less fuel, starts quicker and exhibits less wear and tear.

DEFA WarmUp

Comfort and safety

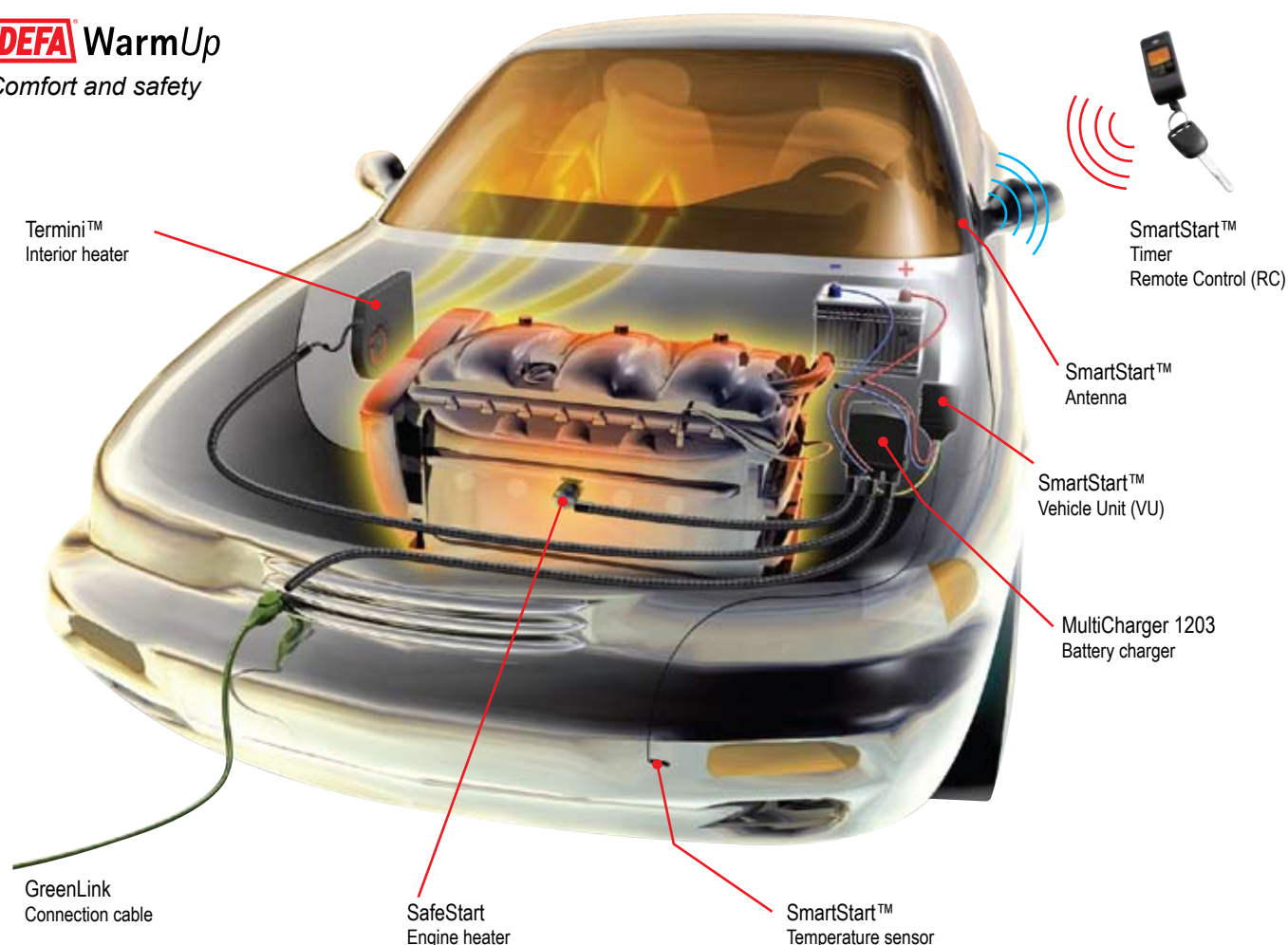



2.2 ENVIRONMENT

A combustion engine emits three primary substances/ classes of substances which damage the environment: Hydrocarbon (HC), carbon monoxide (CO) and nitrogen dioxide (NOx). Diesel engines also emit fine and superfine particles, which are particularly harmful.



CO - Carbon monoxide: Poisonous, colourless and odourless gas which can lead to cardiac arrest. It is present in large quantities. The elderly and children react more sensitively than the average person.

HC - Hydrocarbon: Carcinogenic, mutagenic and can damage the reproductive system.

NOx - Nitrogen dioxide: Poisonous, leads to difficulty in breathing, impaired pulmonary function and impaired resistance to respiratory infections. Can cause damage to the ozone layer.

Diesel particulate - Harmful for people with heart and lung disease, can lead to allergic diseases and cancer.

Diesel exhaust contains about 100 times as much soot particulate as petrol exhaust. In the European market, the demand for diesel vehicles has increased significantly in recent years.

How catalytic converters work

The catalytic converter is heated by the engine exhaust. Until the catalytic converter reaches its operating temperature, its cleaning function is greatly limited.

Depending on the outside temperature, the car may need to be driven for several kilometres before the catalytic converter exhibits optimum performance. The fuel mixture of vehicles with catalytic converters is set to burn richer so that the engine will start better when it is cold. This results in greater emissions of CO and HC. A warm engine produces substantially less harmful exhaust gas. Depending on the number of cold starts per year, every passenger car driver can reduce harmful exhaust gas in the first 4 km by 60 to 80%. The latest research shows that after a cold start in a normal winter, passenger car engines discharge 90% of all CO and HC exhaust gas produced in the first few kilometres. Hence, starting up with a warm engine during the cold season makes a significant contribution towards protecting the environment.

DEFA regularly conducts comprehensive tests for exhaust gas emissions and fuel consumption at a test laboratory in Finland. The following pages contain a summary of the latest test results.



Cold start test with/without engine heater

Exhaust gas emissions and fuel consumption of petrol and diesel vehicles were measured at cold start, with and without an engine heater. The tests were conducted in a cold chamber at -20°C at the testing centre in Tiillä Oy in Finland. 13 test vehicles were chilled down to -20°C and two series of tests were conducted: with and without an engine heater. For the cold start test with engine heater, the heater was switched on 3 hours before the test. Diesel and petrol engines alike were both tested using this procedure. In addition, tests were also conducted at -10°C with the process described above.

For petrol vehicles with an engine heater, the test indicated a substantial reduction of CO and HC exhaust gases (50 to 80%) in the first few kilometres. However, NOx and CO₂ emissions were essentially unaffected by the engine heater. Fuel consumption in the first few kilometres was also reduced by about 15 to 30 % with an engine heater. For diesel vehicles with an engine heater, CO and HC exhaust gases in the first few kilometres were reduced by 40 to 50%. In addition, CO₂ emissions were able to be reduced by 8 to 12%, NOx emissions by 12 to 18% and particulate emissions by 15 to 35%. Diesel fuel consumption was about 8 to 12% lower. Most significantly, the tests indicate that emissions and fuel consumption in the first few kilometres can be reduced. There were also fluctuations in the measurement values which can be attributed to the tests being conducted on different types of vehicles with different engine sizes and types. The tests do indicate, however, that compared to vehicles without an engine heater, the cold start performance of all vehicles tested with various types of DEFA engine heaters can be significantly improved.

Diagram **D1** shows fuel consumption with and without a DEFA engine heater at -20°C .

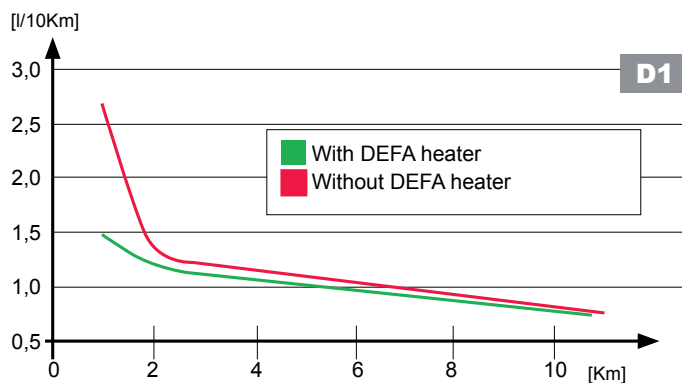

The end result of the tests shows that the use of an engine heater with petrol and diesel engines can achieve the highest reduction for CO and HC emissions. However, CO₂ emissions are also influenced to a lesser degree with petrol engines. With diesel engines, the engine heater has a relatively significant impact on the reduction of NOx and particulate emissions.

Exhaust gas emissions and fuel consumption **D2** were measured on a rolling test bed, which simulates city driving in four identical sequences C1-C4 in continuous operation (4 cycles x approx. 1 km) and cross-country driving C5 (1 cycle x approx. 7 km) in accordance with EU directive 70/220/EEC and 98/69/EC (EURO-3 driving program). Exhaust gas emissions and fuel consumption were measured after completion of the five individual sequences.

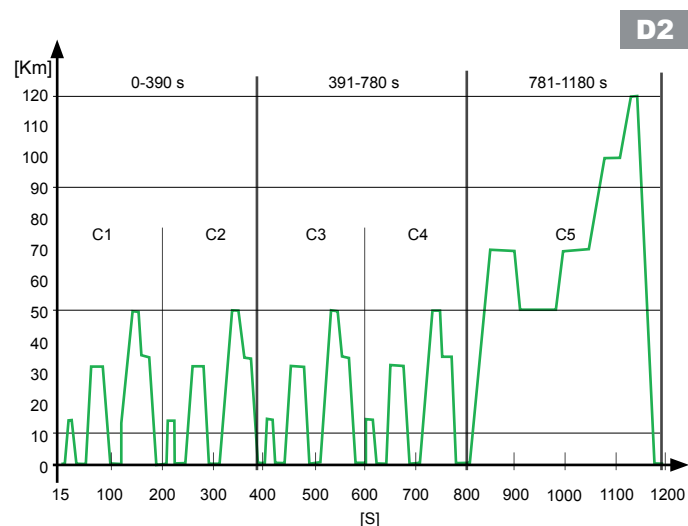

2 - DEFA WarmUp



The end result of the tests shows that the use of an engine heater with petrol and diesel engines can achieve the highest reduction for CO and HC emissions. However, CO₂ emissions are also influenced to a lesser degree with petrol engines. With diesel engines, the engine heater has a relatively significant impact on the reduction of NO_x and particulate emissions (PE).

Diagram **D3** shows the average reduction in fuel consumption and in CO, CO₂, HC, NO_x and particulate emissions for diesel vehicles when a DEFA engine heater was used over the course of a specific road-test route at -20°C.

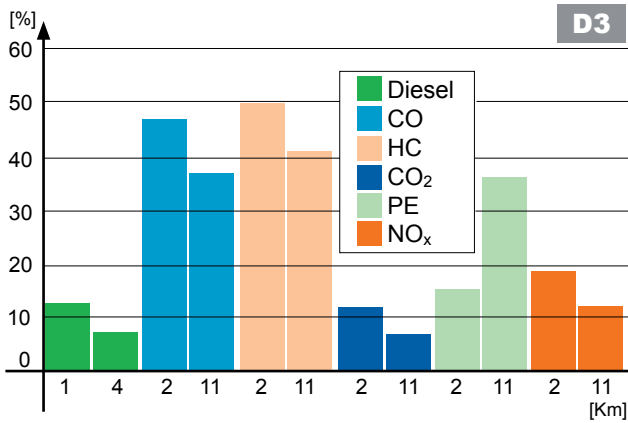
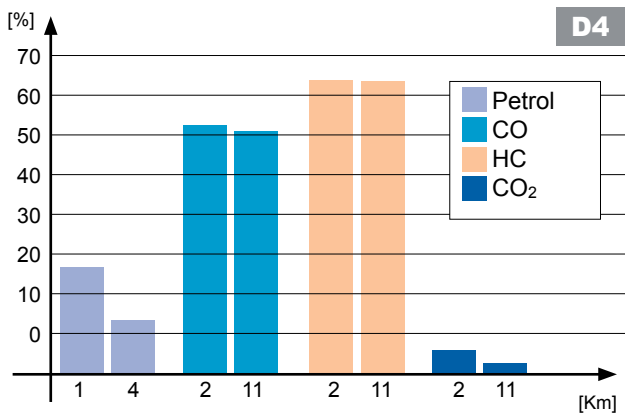
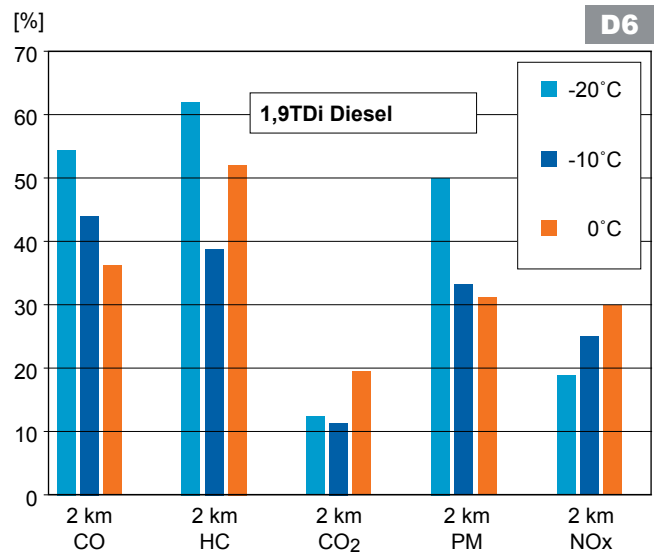
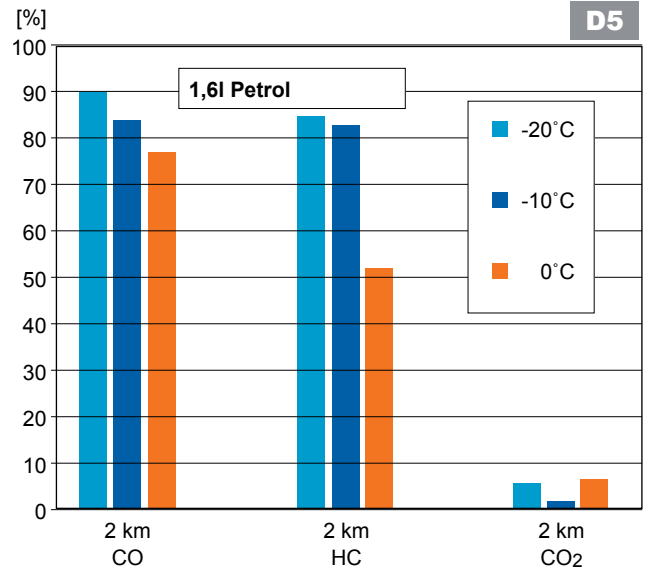

Diagram **D4** shows the average reduction in fuel consumption and in CO, CO₂, and HC emissions for petrol vehicles when a DEFA engine heater was used over the course of a specific road-test route at -20°C.



Diagrams **D5** and **D6** show the reduction of CO, HC, CO₂, particulate and NO_x, and the effectiveness of the engine heater for a 1.6 litre petrol engine and a 1.9 litre diesel engine at 0°C.



2 - DEFA WarmUp



Diagram **D7** exemplarily shows the temperature curve of the engine when the coolant is heated (series 700 hose heater).

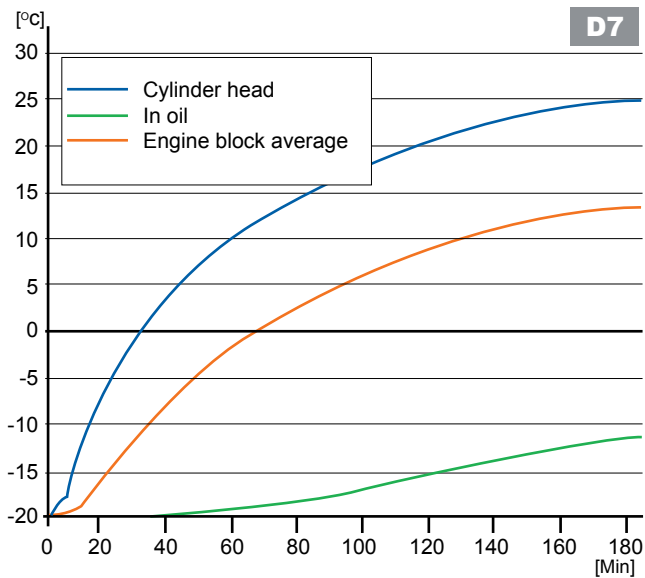
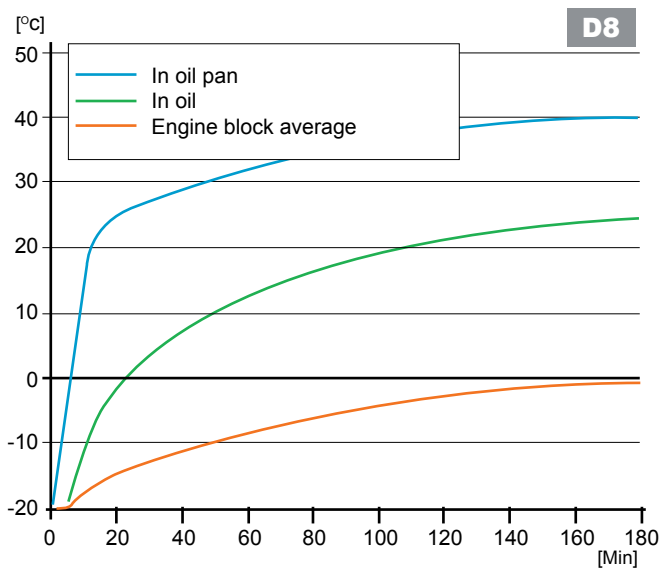

Diagram **D8** exemplarily shows the temperature curve of the engine when the motor oil is heated (series 800 contact heater).



The analysis shows that the use of DEFA engine heaters significantly reduces engine wear.

Diagram **D9** shows the content of Cu (copper), Fe (iron) and Mo (molybdenum) in the oil after 30 cold starts at -20°C, with and without a DEFA engine heater.

The tests were conducted using a relatively new vehicle with fresh motor oil. In total, 30 cold start cycles were carried out. First, the vehicle was cooled down to -20°C. Then the engine was started and allowed to idle for about one minute. After the engine was cooled back down to -20°C, it was started again.

Motor oil samples were taken before and after the test for comparative analysis at the laboratory. Then the tests were repeated with engine heaters.

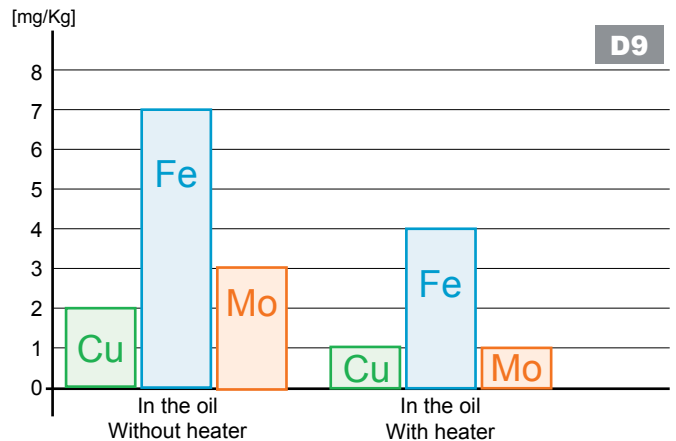

2 - DEFA WarmUp



2.3 SAFETY

Sitting down in a cold car with iced-up windows is not the best way to start the day. Even though snow and ice can be scraped off of the outside of the windows, moisture and condensation quickly causes ice and fog to form on the inside. This often leads to serious accidents which are caused by extremely poor visibility. With DEFA WarmUp, iced-up windows and having to scrape ice become a thing of the past.

2.4 EFFICIENCY

Temperature-controlled activation

DEFA WarmUp is designed to heat-up the engine and vehicle interior as quickly as possible. Hence, it is extremely inefficient to allow DEFA WarmUp to run any longer than absolutely necessary: equilibrium of heat is achieved after approximately 3 hours. Any power consumed after this is used solely to maintain the temperature. Excess energy is released into the environment.

DEFA WarmUp's time-program control ensures that a vehicle will be warm at the desired time, whilst consuming a minimum of power. Temperature-controlled (automatic) activation of the system offers an extremely cost-effective means of operation, as the system only stays on for the required time. The higher the outside temperature, the less time the system remains switched on.

The starting power of a car's battery is drastically reduced when it is cold. (At -18°C , starting power is reduced to only 40% of the original value.) The supply of power in modern vehicles is definitely safer and better, but power consumption is also much greater. This is due, for example, to front and rear windscreen heaters, seat heaters, power windows, normal heaters, etc.

DEFA WarmUp ensures that the battery is always fully charged, and also prolongs the service life of the battery. And the longer batteries last, the less the impact on the environment.

2.5 COMFORT



Snow, ice, hoarfrost and fog disappear, the interior temperature is raised to room temperature and the driver is spared a cold and uncomfortable car. The engine reaches operating temperature more quickly and the car's heater is able to deliver warmth faster. Scraping ice and paying fines for poor visibility are a thing of the past! A freezing driver simply cannot drive well. The freezing cold instantly distracts the driver and makes it difficult to concentrate. Research shows that a stiff neck and back pain are inevitable when the day begins in a freezing cold car. Skeletal muscles become tense and the flexibility of the discs is impaired.

2 - DEFA WarmUp



2.7 TIMER - SmartStart™ / Futura

SmartStart™ and Futura timers (time-program controllers), with which DEFA WarmUp is equipped, ensure that the vehicle will be warm at the desired time. The devices offer two independent departure times. The departure time is the time at which the vehicle is supposed to be ready for use. Departure times are repeated every day and are thus ideal for vehicle owners who use their vehicle every day at the same time. The activation time is the duration of time the heating system remains active before the vehicle will be used. This period can be simply selected or automatically controlled by the system via an outside temperature sensor.

The following programs can be selected:

- Automatic activation, controlled by outside temperature
- Activation time: 1 hour
- Activation time: 2 hours
- Activation time: 3 hours
- Activation time: 4 hours (SmartStart™ only)
- Direct activation of DEFA WarmUp
- DEFA WarmUp **OFF**
(Nothing will be displayed in the Futura display.)

In order to operate DEFA WarmUp as efficiently and economically as possible, we recommend the use of the **Automatic** function provided by the DEFA Timers

The DEFA WarmUp Timers are not only state-of-the art, they also offer many additional functions.

2.7.1 SmartStart™ 12V

SmartStart™ is a hand-held transmitter, consisting of two units.

VU = vehicle unit (installed in the engine compartment)

RC = remote control (hand-held transmitter)

The units communicate via an antenna. Information is stored in the VU (transceiver module, installed in engine compartment) and called up by using the RC (remote control), assuming that the operator is within range of the vehicle.

Some of the important functions of SmartStart™ and technical data are described below.

A complete operating manual for DEFA SmartStart™ is provided as a separate document on the mini-CD which is enclosed with the product. This information is also available on our website.



Remote control

Range of up to 1200 metres in open areas. Obstructions such as walls etc., will reduce the range.

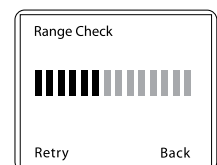

Two user profiles

With DEFA SmartStart™, you can create two different user profiles; a useful function if several people will be using the same vehicle.



Selecting the menu language

The default language for the DEFA SmartStart™ menus is English. Swedish, Finnish, German and Norwegian are also available for selection.

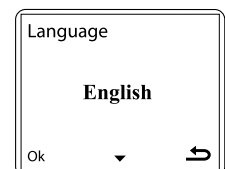

Swedish
Finnish
German
Norwegian



The departure time is the time at which the vehicle is supposed to be ready for use.

2 - DEFA WarmUp



Five- or seven-day week program

You can choose whether the departure times should be active for a five- or seven-day week. The factory default setting is for a five-day week. If a five-day week is selected, the departure times will be inactive on Saturday and Sunday.

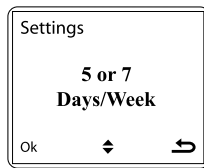
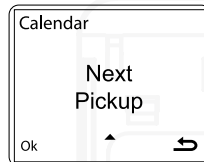

Diagram **D10** shows a system in which the temperature sensor is installed, for example, in the bumper. The automatic function then uses a common temperature sensor to control both the interior heater and the engine heater.

Date-controlled activation time

With DEFA SmartStart™, you can set a date-controlled activation time as the next departure time. DEFA WarmUp will only be activated again at a set time, which is especially practical if you leave your vehicle in a car park at the airport while travelling.



Departure times

As a factory default, departure time **I** is set for 08:00 and departure time **II** for 16:00. In **Aut** mode, the heating system is automatically activated according to the outside temperature.

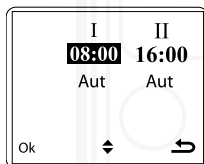

Oversleep

2 hours beyond the departure time - if the vehicle is not started at the programmed departure time, DEFA Warmup remains active for an additional 2 hours.

Ignition signal

DEFA WarmUp: voltage loss
Fuel heater: blue cable

The ignition signal remains suppressed for the remainder of the heating time.

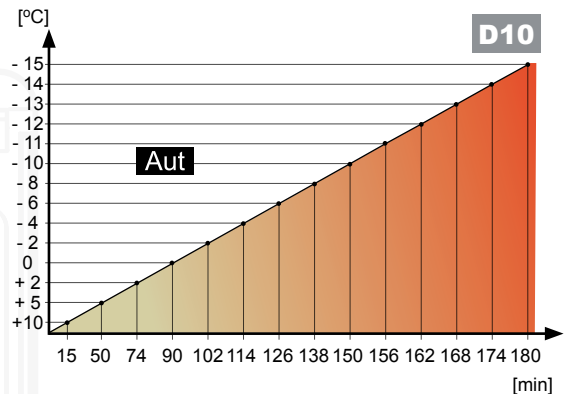

Separate activation times

It's possible to set separate activation times for the interior heater and the engine heater. This setting requires the use of an additional DEFA relay **D23** and a separate cable. Then you will have the option of setting separate times for the engine and interior heaters. After you have selected the separate control of engine and interior heaters, switch to the heating program (above). Now you have the option of setting separate times for the engine and interior heaters.

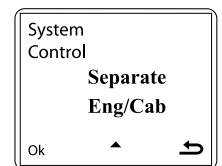

Thermostat setting

The temperature sensor can be used as a thermostat for the interior or the engine. The thermostat function requires that the system is set to separately activate the engine and interior heaters. If the system is not set to control the engine and interior heaters together, the thermostat function will not be available.

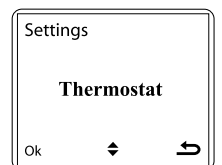

Timer

DEFA SmartStart™ has a stopwatch which also enables periods of inactivity to be ascertained.



2 - DEFA WarmUp



Fuel heater control

In addition to controlling DEFA WarmUp, SmartStart™ is also capable of controlling fuel-based vehicle heating systems, provided access to an analog signal from the fuel based pre-heater.

Note! For safety reasons, fuel-based systems must be switched on manually.

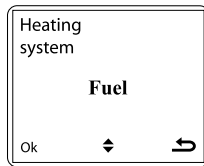

Heating program - fuel

If an external, fuel-based vehicle heating system is integrated, SmartStart™ displays A-3 as standard. A1 through A5 represent levels of activation time according to the size of the vehicle. A1 applies to small vehicles, A3 for mid-sized vehicles and A5 for large vehicles. (e.g. vans, SUVs, etc.) Refer to diagrams D11-D13 for further details.

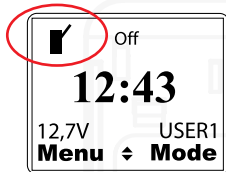

Technical data

Product name: SmartStart™ Item number: 440020 (12 V) / 440021 (24 V)

	Time-program control (RC)	Vehicle unit (VU)
Operating temperature*	-10°C < T < 60°C	-40°C / +80°C
Relay output		100 mA max.
Battery type	6V Lithium. 2CR-1/3N	Vehicle battery
Range**	Up to 1.2 km with unobstructed view	
Frequency [MHz]	868,370 MHz	
Power consumption	<5 µA	<10mA

Testing and certification

EMC in accordance with EN 301 489-1:2005-04 and EN 301489-3:2002.08.

Radio test in accordance with ETSI EN 300 220-1:2000-09

Emissions test conducted in accordance with specifications of EN 301489-1 on meeting the requirements of 2004/104/EC.

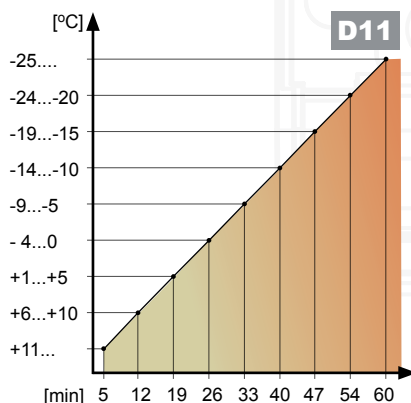

A-1

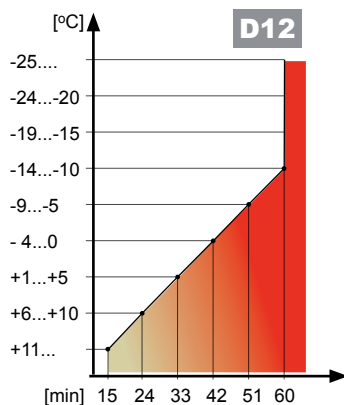

A-3

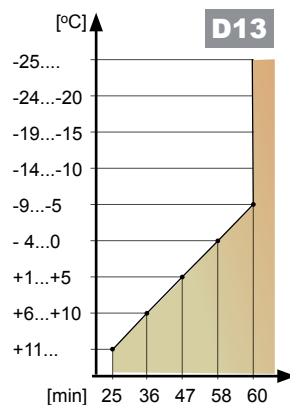

A-5



* Extremely cold temperatures can cause the display to indicate that the battery needs to be replaced, even when it is not necessary. Only change the battery if the indication is given while at room temperature (DEFA item no. 418103). ONLY USE LITHIUM BATTERIES.

** The range is significantly impaired by obstructions such as walls, other vehicles, etc. You can re-establish contact in such circumstances by slightly changing your position or by aiming SmartStart™ at the top or bottom of the vehicle.

2 - DEFA WarmUp



Spare parts

- #418100 SmartStart™ hand-held unit.
(RC = remote control)
- #418103 6V lithium battery
- #418101 Unit installed in vehicle. (VU = vehicle unit)
- #418072 Complete wiring harness between item no. 418101 and DEFA battery charger and/or relay for controlling fuel-based heating systems. Spare part no. for temperature sensor no. 418071.

Replacing the battery



<p>#418100</p> 	<p>#418103</p>  <p> Lithium</p>
<p>#418101</p> 	<p>#418072</p> 

2.7.2 SmartStart™ 24V

Can also be operated at 24V. SmartStart™ offers the same functionality as 12V. SmartStart™ 24V relay control requires the use of a 24V relay box. See the 24V circuit diagram **D20** on page 42 for further details.



A LITHIUM BATTERY MUST BE USED.
DURACELL 28L OR SANYO 2CR- 1/3N
(Spare part no. 418103)

2 - DEFA WarmUp



2.7.2 Futura

DEFA Futura displays the outside temperature, offers an integrated black ice warning and shows the battery/charging voltage. The unit is equipped with an illuminated display which is switched on when the engine is started or when one of the buttons is pressed.



After the time-program controller has been installed and supplied with power, the integrated clock can be adjusted and the desired departure and activation times can be programmed.

If the display lighting on the time-program controller is not on, only this lighting is switched on when one of the buttons is pressed for the first time.

Button functions:

Function button

Each time the button is pressed, the time-program controller displays (in succession):

- 24 h clock
 - Departure time I - factory default setting 08:00
 - Departure time II - factory default setting 16:00
 - Battery voltage
 - Outside temperature in °C
- * The installation of an outside temperature sensor is required for this.

If the battery voltage and outside temperature are not displayed, an outside temperature sensor is not installed. In this case, the time-program controller will alternate between 24 h clock, departure time I and departure time II each time the

Arrow buttons

These buttons are used to adjust the time and to program departure times.

Heating button

The heating button enables the selection of various pre-set heating programs. Each time

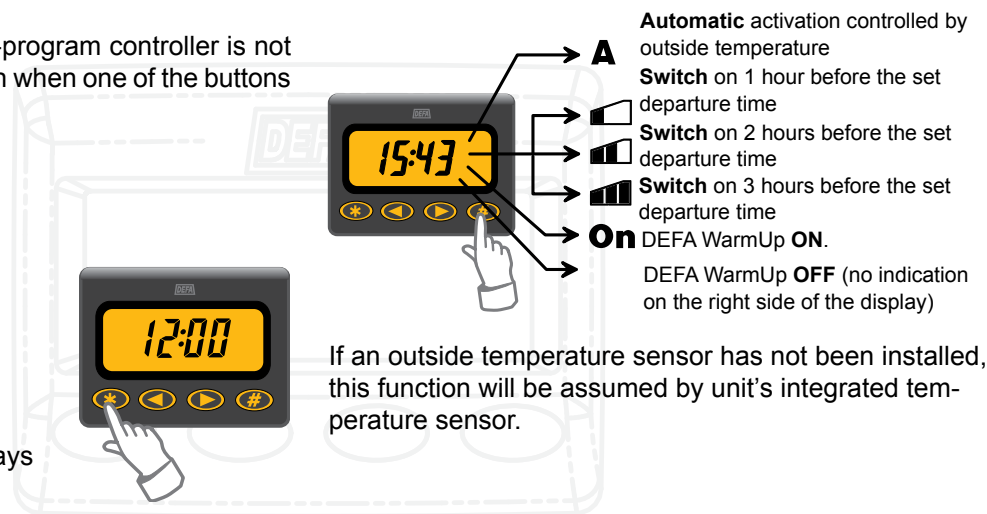

If an outside temperature sensor has not been installed, this function will be assumed by unit's integrated temperature sensor.

2 - DEFA WarmUp



Temperature-controlled activation

When automatic mode **D14** is selected, the temperature sensor measures the outside temperature and autonomously determines the activation time according to the programmed departure time. If an outside temperature sensor was not installed, the interior temperature sensor in the timer measures the temperature. The lower the temperature, the longer the system has to stay switched on in order to achieve the desired temperature for the engine and interior. We recommend activating the automatic mode of the time-program control, as this operating mode is extremely economical. The diagram shows the activation time in minutes according to the outside temperature.

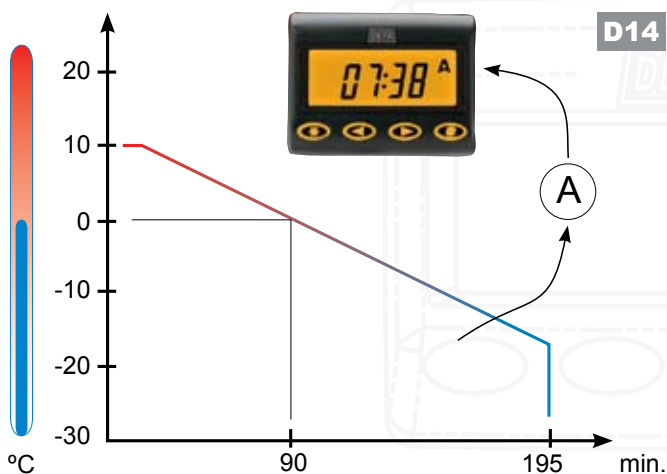

The activation time always relates to the programmed departure time. If the vehicle is not started at the programmed departure time, the activation time is automatically extended by up to 2 hours (oversleep function) beyond the departure time. After that, the system switches off. It only switches on again upon reaching the activation time for the next departure time. This applies regardless of whether automatic mode or an activation time of 1, 3 or 3 hours has been selected. When the vehicle is started, the remaining activation time and the oversleep function are automatically cleared.

Example 1:

At 0°C, the DEFA WarmUp time-program controller switches on 90 minutes before the departure time. During this period, the engine temperature is raised by approximately 30°C (when a 600W engine heater is used).



Example 2:

At -17°C or lower, DEFA WarmUp switches on 196 minutes before the departure time and the engine temperature is raised by approximately 50°C (when a 600W engine heater is used).



The increase in the engine temperature is dependent on the type and configuration of the engine heater.

Setting the time program

1. By pressing , the display will show the time, departure time I or departure time II respectively, depending on which functions you want to change.
2. Simultaneously press both arrow buttons  . The time/departure time will start blinking. The time-program controller is now in programming mode.
3. The arrow buttons are used to set the time/departure time.

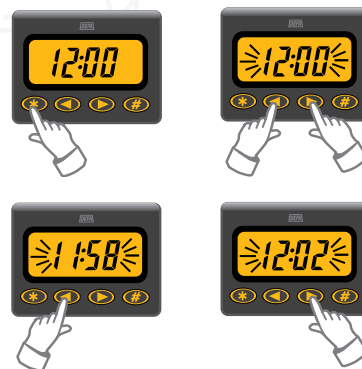

To store the selected time, wait 5 seconds until the blinking stops.

When the time-program controller switches on DEFA WarmUp, the **On** symbol in the display will start blinking.

2 - DEFA WarmUp



Calibrating the temperature

The design of the outside temperature sensor and temperature display should provide the highest possible degree of accuracy. However, if an adjustment is required, proceed as follows:

1. Press until the temperature's shown in the display.
2. Simultaneously press both arrow buttons . The temperature will begin to blink. If the temperature does not blink, then the version of your time-program controller does not support this function.
3. and allow for an adjustment of +/- 3 °C.

Display lighting

When the ignition is switched off, the time-program controller display lighting is switched on by pressing one of the buttons. The lighting stays on for 1 minute after a button was last pressed.

Depending on the utility of the information provided by the time-program controller, the display lighting can be programmed so that it is switched **On** or **Off** while the car is being driven.

Switching display lighting on/off

Press and hold for 5 seconds to switch on the display lighting.

To switch off the display lighting while driving
Press and hold for 5 seconds to switch off the display lighting.

Black ice warning

The time-program controller has a slippery road warning function which triggers a warning when the vehicle enters a temperature range where there is a danger of black ice. This function requires the connection of an outside temperature sensor.

If the vehicle enters a temperature range in which the temperature drops below +4°C or rises above -4°C, a warning will be indicated on the display, the button lighting on the time-program controller will blink for 6 seconds at a fast rate and the temperature will be displayed.

The temperature must change by at least 2°C (compared to the previous warning) before another warning can be triggered. As the first warning is triggered at 4°C, the temperature must rise to at least 6°C and then subsequently drop to 4°C or lower before a new black ice warning will be given. As long as the black ice warning is active, the time-program control cannot be operated.

Starting the engine

When the engine is started, the remaining time (where applicable) before the departure time is cleared and the On symbol will light up in the display. The time-program controller initiates an information sequence and displays the following:

Battery voltage before engine is started, charge voltage after engine is started and outside temperature (each will be displayed for approx. 2 seconds). Afterwards, the time-program controller reverts back to the last function selected before the information sequence. This also applies if an outside temperature sensor is connected.

Switching off the engine

When the engine is switched off, the time-program controller initiates an information sequence and displays departure times I and II. Then it reverts back to the last function selected before the information sequence.



2.8 ENGINE HEATER - SafeStart

An engine heater should generate heat and transfer it to the engine as efficiently as possible. This can be done by means of convective heat transfer with direct heating of the engine fluids (coolant or motor oil) or by heat of conduction with indirect heating of the engine fluids via contact heaters in the engine block or oil pan. An engine heater should achieve equilibrium of heat, controlled by heating time and ambient temperature. Equilibrium of heat is achieved when about the same amount of heat energy that is drawn from the engine heater is delivered to the environment.

DEFA offers many types of engine heaters, depending on whether the vehicle is air or water cooled and how large or small the amount of coolant is. We also offer ideal solutions for tractors, vans, HGVs, other types of motor vehicles and stationary motors.

We have more than 500 different engine heaters in our product range for over 3400 different vehicle models. Our products are divided into 9 main series, which are differentiated by mode of operation and method of fastening.

We use three different series of numbers (411xxx, 412xxx and 413XXX). The last three numbers indicate the heater series.

DEFA strives to offer the optimum solution for each individual engine type. For engine types without accessible frost plugs or caps, there are DEFA engine heaters with special flanges, engine heaters for hose installation and contact heaters.

Every DEFA engine heater should warm up the engine as efficiently as possible, irrespective of the method of fastening. Most DEFA engine heaters are installed with the element directly in the coolant and provide a slow circulation of the warmed coolant. A lead fuse protects against overheating.

The following factors can cause the fuse to burn out:

- Engine coolant level too low, heating element is only partially submerged.
- Air pocket around the heating element.
- Dirty or contaminated coolant, which leads to the gradual formation of an insulating film on the heating element, thus preventing heat from being transferred to the coolant.

When a DEFA engine heater is installed, you can expect the engine temperature to be raised by as much as 50°C above the outside temperature, depending on the configuration and type of heater and amount of coolant.

The ideal activation time is dependent on the outside temperature. Equilibrium of heat is achieved after approximately 3 hours of operation. This means that any power consumed after this point is used solely to maintain the temperature. Any surplus energy is released into the environment. The engine heater can be left on for a prolonged period of time without damaging the heater or the engine. But this would be a needless waste of energy.

DEFA defines "Normal use" as; 3 connections for 3 hours pr. 24 hour based upon 150 users days a year (5 months a year).

It is claimable to make a yearly function control on professional vehicles or engines, like emergency response vehicle or emergency power supplies, where the engine heater is connected 24/7. Yearly service costs will not be covered by DEFA AS.

At many apartment building car parking areas are they using interval power timers turning the power On and Off several times per hour. Using DEFA engine heater in such-like parking facilities will not be considered as "Normal use" and claims will be declined.



DEFA defines "Normal use" as;

3 connections for 3 hours pr. 24 hour based upon 150 users days a year (5 months a year). It is claimable to make a yearly function control on professional vehicles or engines, like emergency response vehicle or emergency power supplies, where the engine heater is connected 24/7. Yearly service costs will not be covered by DEFA AS.

2 - DEFA WarmUp



2.8.1 000 series – Flat conical flange



DEFA number series **001 to 099**. The heater flange consists of a conical washer and the heater is fastened with a press fit. This type of heater is used for engines with a sufficiently large coolant tank, in which the entire heated part of the heating element can be installed. Generally for vehicles with larger engines and a correspondingly large coolant tank. This heater can only be installed in vehicles with cast iron engine blocks.

2.8.4 300 series - Spreader rail



DEFA number series **301 to 399**. The flanges within this heater series are disc shaped or head shaped. A seal is formed between the flange and engine block walls with an O-ring or a rubber gasket. The heater is fastened to the engine block with a fixed spreader rail, which is fitted against the inside walls of the engine block, and a nut/sealing nut to secure the spreader rail. This method is also used if there is not enough space around the heating element for a press fit heater and also for aluminium engines.

2.8.2 100 series - Conical head flange



DEFA number series **101 to 199**. These heaters have a head-shaped flange so that the heated part of the heating element can be installed in the head, either entirely or partially. These heaters are used for engines which do not have a large enough coolant tank. The heater is fastened with a press fit. This type of heater can have one or more conical surfaces with different diameters. This makes it possible to use the heater for different types of engines. This heater can only be installed in vehicles with cast iron engine blocks.

2.8.5 400 series - Hose heater ex/ thermostat.



DEFA number series **401 to 499**. Heaters in number series **420 to 423** are an exception. For this type of engine heater, the flange consists of a metal pipe. The pipe can entirely or partially surround the heating element. The heater is attached to a specific point inside one of the engine's coolant hoses, and is butted against a metal support (e.g. water pump brackets). With this method, the entire heated part of the heating element is surrounded by metal.

2.8.3 200 series - Threaded flange



DEFA number series **201 to 299**. These heaters have a threaded flange and are used in vehicles which have a threaded plug in the coolant tank that is accessible. A seal is formed between the flange and engine block walls with conical threads, an O-ring and a gasket or packing compound. In most cases, the flange is also designed so that the heating element is locked in position while the flange is rotated. The heater flanges within this series are disc shaped or head shaped.

2 - DEFA WarmUp



2.8.5 420 series - Hose heater incl. thermostat



DEFA number series **420 to 423** and are a sub-category of series **400**. DEFA **420,421,422,423** are distinguished from the other series **400** heaters by two basic differences: The heating element is completely surrounded by a coolant chamber. The heating temperature is limited by a built-on thermostat. The thermostat regulates the coolant temperature and switches off the power supply to the element when the coolant has reached a temperature of 80°C at the intake/outlet of the heater. The thermostat switches the heater back on at 70°C.

Note! This is NOT a universal heater - Only to be used on recommended engines and vehicles.

2.8.6 500 series - Special fastener



Heaters with special flange or special fastener are identified with the DEFA number series **501 to 599** and **2501-2599**. Several engine models have very different types of caps that are used instead of a frost plug in the coolant tank. DEFA manufactures a flange for these heaters which is identical to the original cap. The heater is fastened with bolts. A gasket or an O-ring is used to form the seal. There is also a heater available in this series which consists of a flat or head flange, and which is fastened with a holder.

2.8.7 600 series - Oil heater



DEFA number series **601 to 699**. The heaters are used for air-cooled engines and/or in combination with an engine heater for the coolant.

Oil manufacturers have stipulated a maximum value of 2.4 W/cm² for the surface of the heating element in order to prevent any adverse effects on the quality of the oil. For large vehicles with ample-sized oil pans, the heated part of the element is placed directly in the oil. The power of oil heater is usually rated at 250W. Therefore, these elements do not have a lead fuse.

Oil heaters can be divided into two different groups:

- Heaters for which the element is installed in place of the lid or cap on the oil pan.
- Heaters which are installed in the threaded hole in the oil pan.

Also see Series **800** for indirect heating of the oil inside the oil pan.

2.8.8 700 series - Hose heater



DEFA number series **701 to 799**, and they can be divided into two different groups:

- Heaters without thermostat
- Heaters with thermostat

Heaters without thermostat

These heaters are identified with the DEFA number series **701-709** and **758-799**. The heaters consist of a heating element and a coolant chamber with intake and outlet connections for different hose dimensions. Heaters **758-799** do not have a thermostat and are suitable for various types of installation methods (hoses, T-connectors, hose clamps, etc.).

They are usually installed in a hose on the oil cooler or in a hose for the internal vehicle heater.

2 - DEFA WarmUp



710-757 - With thermostat



DEFA number series **710 to 757** and they consist of heater **715** for various installation methods (hoses, T-connectors, hose clamps, etc.). Heater **715** consists of a coolant chamber with an element and a power connection box. There is thermostat in the connection box which measures the temperature on a metal plate between the connection box and the coolant chamber. Intake and outlet connections are designed to accommodate 5/8" or 16 mm hoses. The heater is equipped with a thermostat that regulates the coolant temperature and switches off the power supply to the element when the coolant has reached a temperature of 80 °C at the intake/outlet of the heater. The thermostat switches the heater back on at 70°C.

721-734 - With thermostat



The heater consists of a coolant chamber and a power connection box. There are 2 two-phase thermal fuses and thermostat in the connection box which measure the temperature on a metal plate between the connection box and the coolant chamber. The fuses in the heater prevent the heating element from failing due to overheating.

Overview of heaters with different thermostats (T) and power ratings (N) at 230V:

N \ T	700W (6-12 L)*	1000W (12-18 L)*	1500W (16-24 L)*	2000W (22 L >)*
80°C	411721	411722	411723	411724
60°C	411727	411728	411729	411730
40°C	411731	411732	411733	411734

* Recommended used on engines with cooling system in litres (L) of coolant.

2.8.9 800 series - Contact heater



DEFA number series **801-899, 2801-2899 and 3801-3899**.

Contact heaters can be divided into two different groups:

- Heaters for engine blocks
- Heaters for oil pans

Contact heaters consist of an element cast in aluminium, which is adapted to fit the installation point. Contact heaters for oil pans are essentially oil heaters which heat up the oil instead of the coolant. The rise in engine block temperature produced by a contact heater for oil pans is thus not comparable with an engine heater which heats up the coolant. A heat conducting paste is applied to the contact surfaces of the heater in order to improve the transfer of heat from the contact heater to the engine block or oil pan.

2.8.10 Technical data

DEFA engine heaters have a nominal power rating of between 175W and 2000W, depending on the size of the engine that is to be heated. DEFA engine heaters are compliant with the following standards: EMKO-TUB(61)NO 293/91, EN 60335-1 and EMKO-TSB(61)NO293A94.

	Coolant heaters	Oil heaters	Contact heaters
Power	550-2000W	175-370W	300-400W
Voltage	230V		
Protection class	IP44		



2.9 INTERIOR HEATERS Termini™ / Termina



DEFA interior heaters utilise a PTC heating element (PTC = Positive Temperature Coefficient), which adapts the power output according to the temperature of the intake air. A rise in temperature of 20°C results in a reduction of power output by about 20%. As the interior temperature rises, power output is reduced and thus power consumption as well. The interior heater is equipped with an automatic overheating circuit breaker. If this breaker is tripped, it is reset by disconnecting the plug and leaving the interior heater switched off until it cools down (after approximately 30 minutes). There is also a lead fuse for additional protection. If this fuse blows, the interior heater must be sent to the factory for repair.

The interior heater is mounted in the interior of the vehicle with special holders.

2.9.1 Range of application

Termina 1400 and Termini™ 1350/1850, from small cars up to mid-sized estate cars.

Termina 2000 and Termini™ 2100, from large saloon cars up to HGV cockpits.

2.9.2 Technical data

The table for Termini™ also indicates the power consumption for two different ambient temperatures.

Termini™	1350	1850	2100
Power level (W) - 25 °C	0/1350	0/850/1850	0/1300/2100
Power level (W) +25 °C	0/1100	0/720/1560	0/1060/1700
Width (mm)	138	141	
Height (mm)	35	47	
Depth (mm)	181	183	
Weight (g)	595	745	
Holder (g)	20		
IP rating	20		
Certification	EN 60335-1, EN60 335-2-30 , NEK 554		

Termini™ uses patented technology.

The table for Termina indicates the power consumption for an ambient temperature of -25°C.

Termina™	1400	2000
Power level (W) - 25 °C	0/800/1400	0/1100/2000
Width (mm)	146	200
Height (mm)	75	90
Depth (mm)	165	200
Weight (g)	890	1300
Holder (g)	35	
IP rating	20	
Certification	EN 60335-1, EN60 335-2-30 , NEK 554	



2.9.3 Interior heating test

The following test results are from tests conducted in a cold chamber, and they illustrate the effectiveness of interior heaters.

The tests were conducted in a cold chamber at a temperature of -20°C . The interior heaters were switched on and measurements were taken over the course of 120 minutes. The diagrams show the rise in temperature at individual, select measurement points in the interior of a typical vehicle.

Diagram **D15** shows the heating curves for the interior when heated with Termini™ 2100. The tests were conducted on a large SUV.

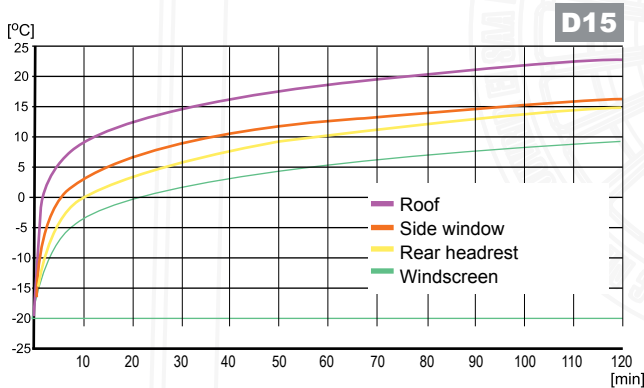

After 2 hours of operation, the greatest measured rise in temperature was 43°C . As can be seen in the diagram, the greatest rise in temperature occurred within the first few minutes. The average increase over the last hour was merely 4°C . The heating curves progress asymptotically, so that the average increase after another hour of operation is even lower.

Diagram **D16** shows the heating curves for the interior when heated with Termina 1400 and Termini™ 1350. The tests were conducted on a normal, mid-sized passenger car with notchback.

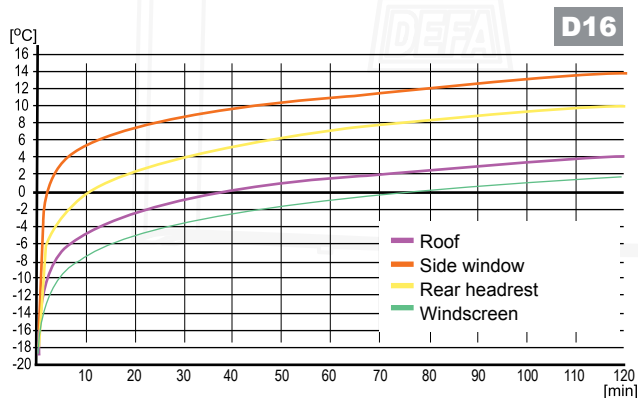

The de-icing characteristics of interior heaters are shown in the following illustration before and after a 2-hour test.



BEFORE



AFTER



2.10 BATTERY CHARGER - MultiCharger

DEFA battery chargers are suitable for vented and valve-regulated batteries. The acid content of vented batteries can be measured. Valve-regulated batteries are subdivided into two categories: Gel batteries and AGM batteries (AGM = absorbed glass mat). In AGM batteries, the acid is in a free-flowing state, but it is absorbed by a glass-fibre mat. In gel batteries, the acid contains an additive which causes it to form a gel.

The charging current for batteries should generally be below 20% of the battery capacity (in Ah).

2.10.1 MultiCharger 1203 3A

The charger functions independently of the time-program control.

The charger is primarily designed for passenger cars.



Features:

- Modern switch-mode charging electronics, which help to preserve the battery. Therefore, the charger can be permanently connected.
- The temperature-compensated charging voltage ensures that the battery will be fully charged in all conditions.
- LED indicator for charging mode and quick charging mode (green and red).
- If the battery is so heavily loaded during the trickle charging process that the battery voltage drops to below 13V, the charger automatically switches to full-power mode (quick charge mode).
- The battery has short-circuit protection and reverse-polarity protection. This requires the installation of the enclosed fuse.
- 230V recognition, which prevents the relay from staying switched on and discharging the battery when the charger is not in use.
- 2 relay-controlled outputs for engine and parking heaters which can be activated with a time-program controller (external signal).
- Will not damage sophisticated electronics.
- Compact dimensions
- Protects the battery from degradation (sulphating) and extends the service life of the battery.
- Prevents the release of harmful gases (safety).

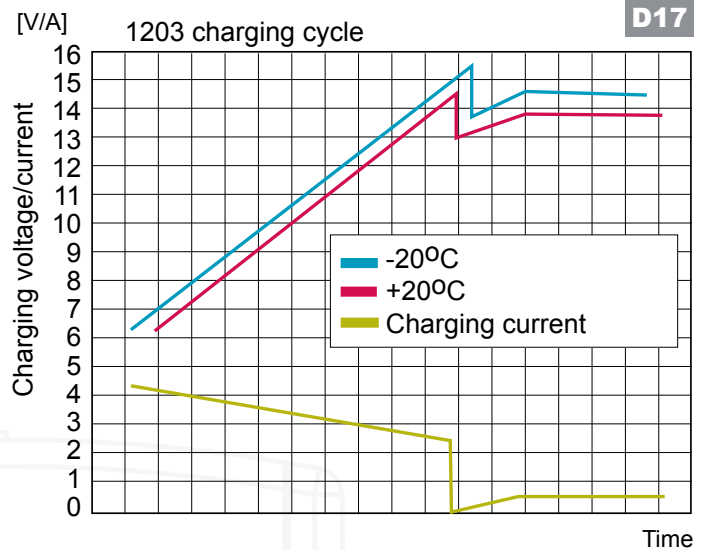

2.10.2 MultiCharger 1210 10A

This charger can be used not only for passenger cars, but for the following applications as well:

- Caravans
- Agricultural machines
- Boats
- Motorhomes
- Buses and HGVs
- Transporters
- Wheelchairs



Features:

- Modern switch-mode charging electronics, which help to preserve the battery. Therefore, the charger can be permanently connected.
- The temperature-compensated charging voltage ensures that the battery will be fully charged in all conditions.
- LED indicator for charging mode: quick charge mode (red) and trickle charge mode (green).
- If the battery is so heavily loaded during the trickle charging process that the battery voltage drops to below 13V, the charger automatically switches to full-power mode (quick charge mode).
- The battery has short-circuit protection and reverse-polarity protection. This requires the installation of the enclosed fuse.
- The charger is suitable for 12V and 24V systems. (Each battery is charged separately in 24V systems.)

2 - DEFA WarmUp



- Uneven charging is prevented.) Two chargers must be used for 24V systems.
- Temperature monitors to protect the charging electronics.
 - Control voltage for quick charging mode 14.7V at 20 degrees (red).
 - Trickle charging: 13.7V at 20 degrees (green). To compensate for the self-discharge of batteries.
 - The charger has a 230V plug socket which can be used to connect two chargers or to provide power for additional DEFA equipment (without relay control).
 - Enables the trickle charging of batteries during winter storage (e.g. for boats, caravans and agricultural machines).
 - Will not damage sophisticated electronics.
 - Compact dimensions
 - Protects the battery from degradation (sulphating) and extends the service life of the battery.
 - Prevents the release of harmful gases (safety).

2.10.3 Technical data

Information on certifications can be found in chapter 4 under "CE documentation".

MultiCharger	1203	1210
Rated power [W]	45	125
Charging current [A/V]	3/12	10/12
Operating temperature [°C]	-40/+40	-40/+40
Quick charging voltage [V]	>14,7	>14,7
Maintenance charging [V]	13,7	13,7
Protection class	IP54	IP54
H/W/D [mm]	80/70/45	205/130/65
Weight [kg]	0,24	0,50
Fuse rating 12 V [A]	5	15
Charging cable cross section [mm ²]	0,75	2,5

H = height, W = width, D = depth

2.11 CONNECTION ACCESSORIES

2.11.1 DEFA MiniPlug

The DEFA MiniPlug is suitable for all new vehicles. It is easily flush mounted to the holder. The DEFA MiniPlug was developed with functional design, safety, maximum ease of installation and optimum user-friendliness in mind.

2.11.2 Extension cable

The main components of DEFA WarmUp can be easily connected with DEFA extension cables. The system provides a means of making safe and reliable connections. DEFA PlugIn contacts prevent improper connections.

2.11.3 DEFA Relay

DEFA Relay **460838** can be used together with both SmartStart™ and Futura timer. Some functions will disappear by use of battery charger MultiCharger 1203. Refer to circuit diagram in the enclosed fitting instructions for DEFA relay.

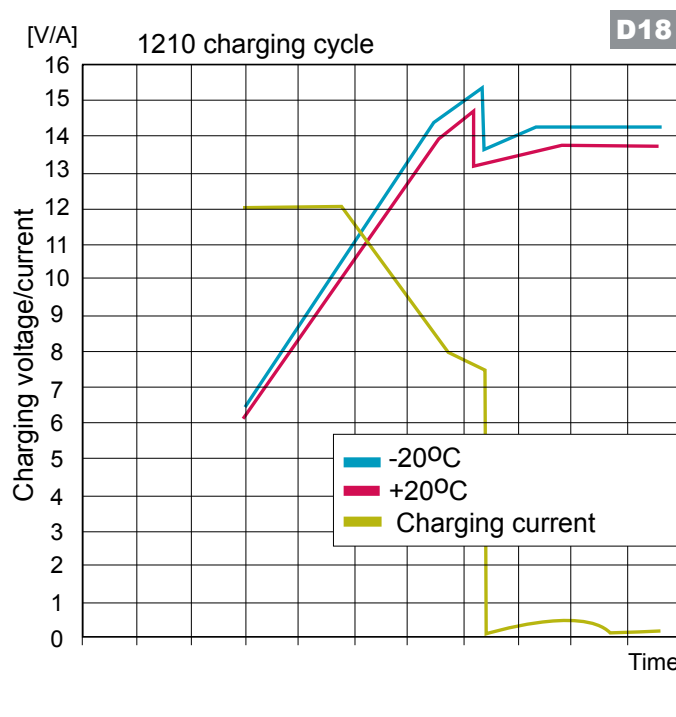

3 - Installation



3.1 GENERAL INFORMATION

DEFA WarmUp is a modular 230V vehicle pre-heating system, which consists of an engine heater, interior heater, battery charger, timer and connection accessories.

DEFA WarmUp is offered in different sizes which correspond to the interior heating requirements. Engine heaters are offered separately, as they are different depending on the vehicle model.

Installation is quick and easy, improper connections are not possible and operation is intuitive and easy for the customer.

The large space requirements for equipment and the aerodynamic design of new vehicles necessitate the adaptation of DEFA WarmUp to these conditions, in order to accommodate and satisfy both installers and users alike. For this reason, we have developed the DEFA MiniPlug - a device connector, which is flush fitting and virtually invisible when installed and which can be mounted on brackets.

DEFA WarmUp consists of small modules and sufficiently long cables, so that installation is possible in almost any type of vehicle. Our unique PlugIn system consists of special 230V cables and extension cables to connect the main components of DEFA WarmUp. The system prevents connection mix-ups and ensures that connections are safe and reliable.

DEFA WarmUp was developed with ease of installation and functionality in mind. The main components of the system are thus very compact, and are supplied with sufficiently long cables to make installation possible in almost any type of vehicle.

However, in order to take full advantage of the length of the cables, the main components must be installed properly.



The instructions on the placement of cables and main components must be followed carefully. No components may be installed close to moving parts such as light systems, fans, steering rods and the like, or near hot engine parts such as exhaust manifolds, exhaust pipes, turbo chargers and the like.

3 - Installation



DEFA WarmUp Termini™ 1350/1850/2100 consists of:

Qty.	Product
1	Termini™ - interior heater with holder
1	SmartStart™ - hand-held transmitter
1	SmartStart™ - VU = unit to install in the engine compartment
1	MultiCharger 1203 - battery charger/relay
1	Extension cable (0.5 m)
1	Extension cable (1.0 m)
1	Extension cable with interior heater plug (1.75 m)
1	DEFA MiniPlug cable (1.5 m)
1	Connection cable (2.5 m)
1	Wiring harness for SmartStart™ and MultiCharger/charger

Fastening accessories for MiniPlug

Qty.	Product
1	Fastening nut
1	Flat washer for nut for curved surfaces
1	O-ring for fastening nut
1	Holder
1	Spacer for holder
2	Black stainless steel bolt M4x20 mm
2	Fastening bolts for PlugIn the holder (3x7 mm)
2	Fastening plugs for the holder
1	Self-tapping screw (4.2x13 mm)

Fastening accessories for other components

Qty.	Product
3	Fastening bolts (3.5x16 mm) for Termini™ holder
8	Fastening strips (200 mm) for extension cable
1	Fuse holder with 5A fuse
1	MultiCharger cable (200 mm) between fuse holder and battery
1	Rubber bushing
1	Fastening bolt (4.2x16 mm) for MultiCharger holder to chassis
1	Fastening bolt (4.2x32 mm) for MultiCharger to holder
1	Holder for battery charger
1	Antenna fastening rail

Installation of DEFA WarmUp Termini™ 1350/1850/2100:

1. Disconnect the battery at the negative terminal. Read the instructions from the vehicle manufacturer before disconnecting the battery.
2. The engine heater is selected according to the model list from DEFA. Install the engine heater at the location as specified in the respective installation manual. Fill the vehicle's cooling system with an approved coolant and bleed air out of the system in accordance with the instructions from the vehicle manufacturer.
3. Determine a suitable path to route the extension cables for the interior heater.
4. Install the interior heater in the interior of the vehicle. Be sure to use the enclosed drilling template for the holder.
5. Install DEFA MiniPlug in an easily accessible spot at the front of the vehicle or where the customer requests.
6. Position the battery charger/relay box in such a way that it can be connected to the extension cables from the interior heater, engine heater and device connector.
7. Install the SmartStart™ vehicle unit (VU) with the cables and connect them to the MultiCharger/relay box.
8. Attach the SmartStart™ antenna outside of the engine compartment.
9. Connect the battery at the negative terminal.
10. Test DEFA WarmUp to ensure that it functions properly.

3 - Installation



DEFA WarmUp Termina 1400/2000 consists of:

Qty.	Product
1	Termina - interior heater with holder
1	Futura - time-program controller
1	MultiCharger 1203 - battery charger with relay
1	Interior heater contact
1	Interior heater cable (1.5 m)
1	Extension cable (0.5 m)
1	Extension cable (1.0 m)
1	DEFA MiniPlug cable (1.5 m)
1	Connection cable (2.5 m)
1	12 V wiring harness for time-program controller and charger/relay box

Fastening accessories for MiniPlug

Qty.	Product
1	Fastening nut
1	Flat washer for nut for curved surfaces
1	O-ring for fastening nut
1	Holder
1	Spacer for holder
2	Fastening bolts for plug in the holder (3x7 mm)
2	Fastening bolts (M4) for the holder
2	Fastening plugs for the holder
1	Self-tapping screw (4.2x13 mm)

Fastening accessories for other components

Qty.	Product
3	Fastening bolts (3.5x16 mm) for interior heater
4	Double-sided tape for time-program controller
8	Fastening strips (200 mm) for extension cable
1	Fuse holder with 5A fuse
1	MultiCharger cable (200 mm) between fuse holder and battery
2	Fastening bolts (4.2x32 mm) for socket
1	Feed through (14x28x7.5 mm)
1	Fastening bolt (4.2x32 mm) for battery charger
1	Fastening bolt (4.2x32 mm) for charger holder
1	Holder for battery charger

Installation of DEFA WarmUp Termina 1400/2000:

1. Disconnect the battery at the negative terminal. Read the instructions from the vehicle manufacturer before disconnecting the battery.
2. The engine heater is selected according to the model list from DEFA. Install the engine heater at the location as specified in the respective installation manual. Fill the vehicle's cooling system with an approved coolant and bleed air out of the system in accordance with the instructions from the vehicle manufacturer.
3. Determine a suitable path to route the extension cables for the interior heater.
4. Install the interior heater in the interior of the vehicle.
5. Install DEFA MiniPlug in an easily accessible spot at the front of the vehicle or where the customer requests.
6. Position the battery charger/relay box in such a way that it can be connected to the extension cables from the interior heater, engine heater and device connector.
7. Place the Futura timer on the dashboard according to your customer's wishes. Use the enclosed double-sided tape.
8. Connect the battery at the negative terminal.
9. Test DEFA WarmUp to ensure that it functions properly.

3 - Installation



Coolant

After the engine heater has been installed, the coolant has to be changed if it is dirty or contaminated. Otherwise, the coolant will cause a film to form on the heated part of the element and the element will burn out.

Bleed the air from the cooling system as per the instructions from the vehicle manufacturer in order to prevent an air pocket from forming around the engine heating element. An air pocket will cause the element to burn out very quickly, thus causing the engine heater to fail.

The engine heater may only be tested after the cooling system has been filled with an approved coolant and the system has been properly bled.



Only use a coolant which has been approved for the respective vehicle model. DEFA WarmUp should only be installed in accordance with the installation manual.

Tools

In addition to the usual tools found in a garage, a special tool is required for the installation of DEFA WarmUp.

The dimensions and order number for the special tool can be found in the model list / in the DEFA parts catalogue.

Drill head

Tool for routing the MiniPlug contact and PlugIn cable in the bulkhead.



Components:

- Hole saw (Ø 24 mm) for MiniPlug
- Hole saw (Ø 20 mm) for interior heater cable
- File for guide slot
- Holder with guide tap

3 - Installation



Removing the frost plug

Series **000**, **100**, **300** and some series **500** DEFA engine heaters are installed in place of the frost plug or cap. The latter must therefore be removed before the heating element is installed. Depending on the configuration and material of the frost plug, different procedures and tools are required.

Extraction tool

Available individually or as a complete set. The main extractor tool (item no. **490888**) is required in order to use the extractor and adapter sleeve. Single extractors and adapter sleeves are available in five different sizes, depending on the inside diameter of the frost plug which is to be removed. (See extractor for diameter.) This tool is also suitable for deep frost plugs. The tool functions like an extractor. It is securely tightened around the side walls of the frost plug by tightening the nut. Next, a suitable adapter sleeve (five different adapter sleeves) is put on. The frost plug is pulled off by tightening the nut. It is important to observe the manual for the tool.

Extractors

Item no.	Ø[mm]
490843	20
490845	27
490846	31
490847	35
490848	41

Complete set: **#490871**

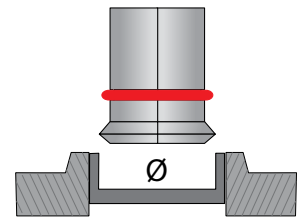

Adapter sleeves

Item no.	Ø[mm]
490881	27
490882	31
490883	35
490884	39
490885	46

Complete set: **#490886**

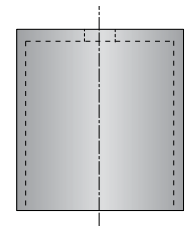

Complete extraction tool set

Main tool + extractors + adapter sleeves: **#490887**

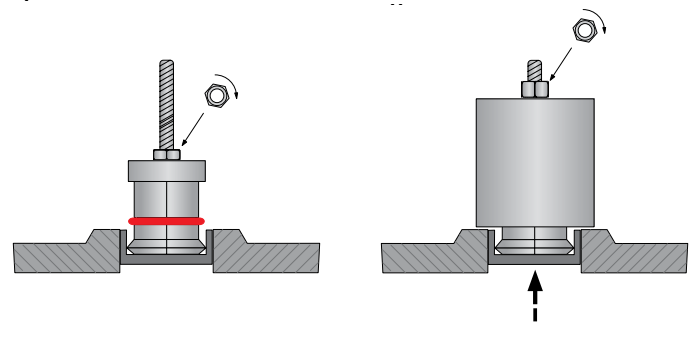

Main extractor tool

Item no.
490888

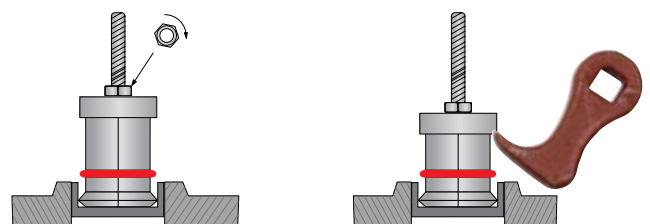

It is imperative that the main tool is in the right position (normally on the frost plug receptacle) when the frost plug is pulled out.

3 - Installation



DEFA extraction hook

When using this tool, we recommend punching a hole in the centre of the frost plug with a pin and hammer before attaching the extraction hook.



The tool is used in combination with a 1/2" ratchet. The extraction hook is available in 3 sizes, depending on the diameter of the frost plug which is to be removed.

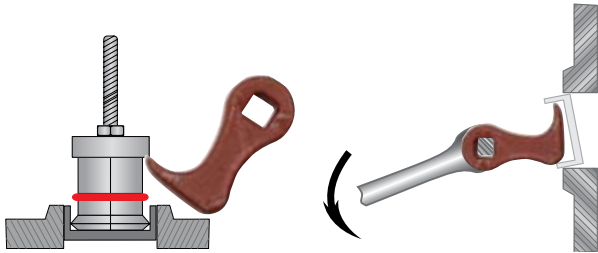

This tool must be used with extreme caution in order to avoid damaging the engine block.

Removing the frost plug

The frost plug can also be removed by inserting a pin on the inside edge of the frost plug which is to be removed. Next, carefully tap the pin with a hammer, pushing it inward. If this is done very carefully, the cap will twist down into the frost plug receptacle. Then the frost plug can be pulled out with extraction pliers or water-pump pliers.

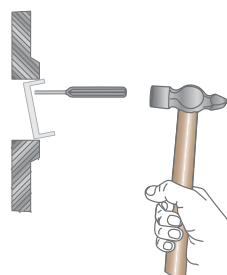

The frost plug may not be hammered into the coolant casing, as this will compromise or impair the circulation of the coolant. On some engine blocks, there is a stop angle behind the frost plug. This procedure cannot be used to remove the frost plug on such engines. The DEFA extraction tool must be used instead.

Special tool for interior feed through

Available in two versions, depending on whether the interior cable will be routed from the engine compartment into the inside of the interior or from the interior into the engine compartment. The tool can be secured with the insulating tape at the passage between the tool and the interior cable. Guide the tool, with the cable threaded in, through the original rubber bushing.



Be careful not to damage existing cables while feeding through the interior cable. Carefully seal the area around the cables with a suitable packing compound.

3.1.2 Direction of the PlugIn contact

In many cases, a specific direction is specified for the PlugIn contact for the installation of the engine heater. This is due to the following reasons:

- The PlugIn contact on the heater may not be located too close to hot parts, such as the exhaust manifold, turbo charger and the like.

- In order to prevent the heater from coming loose, thus allowing coolant to leak out, and in the worst case, causing damage to the engine. The walls of engine blocks (I) have different thicknesses. If the spreader rail or one of its legs bears down on these walls, this can cause the heater to come loose and allow coolant to leak out.

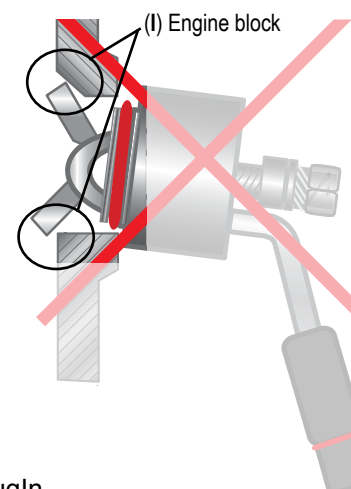

Therefore, it is imperative that the heater is installed according to the installation manual. The PlugIn contact of the element must point towards the specified direction.

3 - Installation



Integration with the vehicle

An increasing demand for environmentally friendly combustion engines and rising oil prices have led to major advancements in engine design. Today, electronics are almost always used to measure coolant and oil temperature, and to regulate combustion.

Electronic control and monitoring systems and increasingly cramped engine compartments have apparently led to logical solutions not being needed any longer.

In a best case scenario, improperly installed engine heaters may prevent the vehicle from starting (the electronics assume that the temperature in the vehicle is higher than it actually is at the time the vehicle is started). In a worst case scenario, improper installation may cause damage to the engine.

The heating of the coolant in the engine block or in the radiator hose not only provides a pre-heated engine, it also enables the car's heater to deliver warmth immediately when the engine is started.

This solution takes advantage of the principle that warm water rises and cold water sinks. Circulation is produced by heating the coolant at the lowest point of the circuit. For optimum results, the heater should thus be installed on the lowest radiator hose.

The installation of a hose heater on a visible and easily accessible radiator hose may be tempting, but the fact that this is not described in the installation manual has a very good reason.

In modern engines, electronic temperature sensors and the like inside the radiator are often incompatible with a hose heater. In this case, the water is not circulated and the coolant will start to boil around the engine heater. This causes the engine heating element to burn out or engine heaters with a thermostat to switch off.

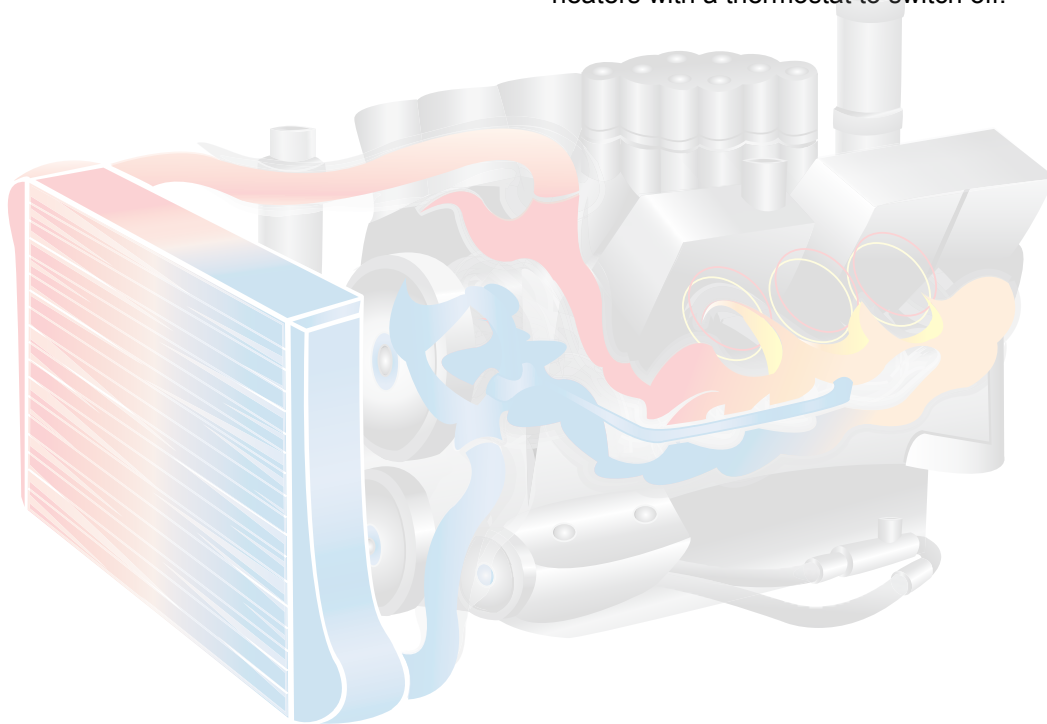

DEFA conducts trial installations, tests and obtains certification for all of its solutions, and creates specific installation manuals for individual vehicles. We are always looking for the simplest, most ideal solution for each individual vehicle. Engine technology which eludes DEFAs monitoring functions may result in solutions which involve a longer installation process than for other engine heaters.

Therefore, it is imperative that the instructions in the enclosed installation manual are followed during the installation of the engine heater.

3 - Installation



3.2 000-100 series - Flat conical flange

The orifice must be thoroughly cleaned for both heater series. It should be free of rust, scratches, paint, score marks and other imperfections which may prevent the element from being securely seated or cause coolant to leak out. When installing the element, it is important to ensure that it is properly seated in the orifice.

Clean the orifice thoroughly after the frost plug has been removed. Use sandpaper if necessary.

Insert the heater in the orifice and check to make sure that it is seated properly and that the PlugIn contact is pointed in the right direction as specified in the installation manual. This is extremely important for the proper function of the heater. Tap the heater securely into place by tapping it in the centre with a hammer and pin. Make sure that the heater is properly seated in the orifice when fixing it in place.



There should always be a small gap between the stop angle (1) of the heater and the engine block wall after the heater has been installed.

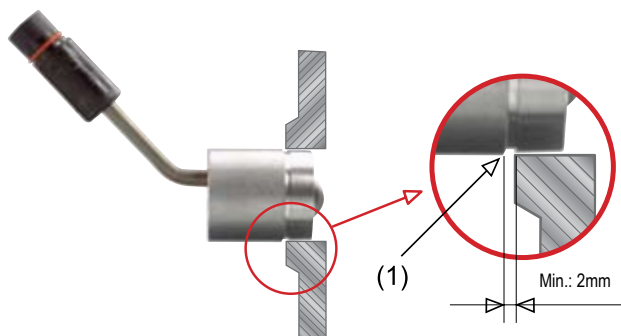

3.3 200 series - Threaded flange

Thoroughly clean the threads in the orifice after the corresponding screw cap has been removed from the coolant cover. A drop of oil on the threaded part of the heater makes it easier to screw in the heater. Guide in the threads of the heater and check to make sure that the threads are seated properly before tightening down the heater. On some heaters, the element can be secured while the heater is being tightened. Make sure that the PlugIn contact is pointing (2) in the right direction according to the installation manual. Seal the heater as instructed in the installation manual.

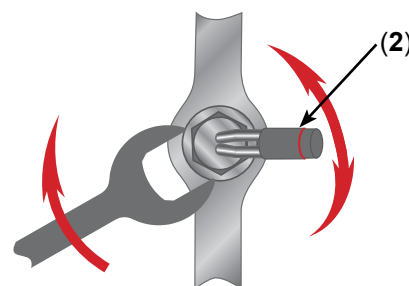
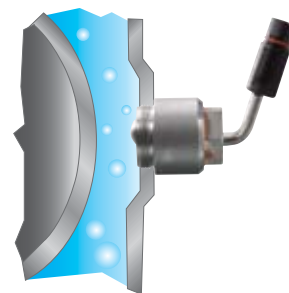

DO NOT disassemble the heater before it is installed.

A drop of oil on the threaded part of the heater makes it easier to screw in the heater. Guide in the threads of the heater and check to make sure that the threads are seated properly before tightening down the heater.



3 - Installation



3.4 300 series - Spreader rail

When installing this type of heater, it is important to ensure that the spreader rail lies flush against the engine block wall inside coolant chamber. Engine block walls have different thicknesses. If one of the legs of the spreader rail bears down on these protrusions, this can cause the heater to become loose and/or detach. In a worst case scenario, it could also damage the engine.

Therefore, it is imperative that the heater is installed according to the installation manual. The PlugIn contact of the element must point towards the specified direction. The orifice must also be thoroughly cleaned. It should be free of rust, scratches, paint, score marks and other imperfections which may prevent the element from being securely seated or cause coolant to leak out.

3.4.1 Procedure for a spreader rail

Insert the heater directly into the frost plug orifice so that the PlugIn contact on the element is pointing in the direction specified in the installation manual. Pull the heater up to the engine block wall. Make sure that the spreader rail is positioned between the element tubes. Rotate the heater by $\pm 5^\circ$ to ensure that it is properly seated, then torque the nut to 6 Nm.

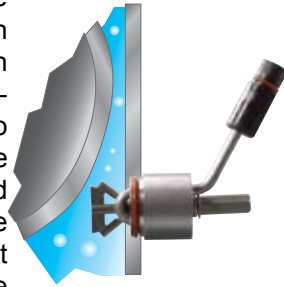

3.4.2 Fixed T-rail

Unscrew the nut almost completely, hook the spreader rail into the frost plug receptacle and place the heater in the receptacle. Make sure the heater is in the correct position. The PlugIn contact on the element must point towards the direction specified in the installation manual. Use the nut to pull the heater up to the engine block wall. Make sure that the spreader rail is positioned between the element tubes. Rotate the heater by $\pm 5^\circ$ to ensure that it is properly seated, then torque the nut to 6 Nm.

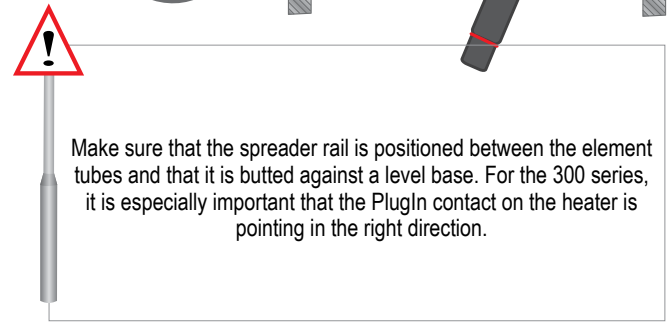
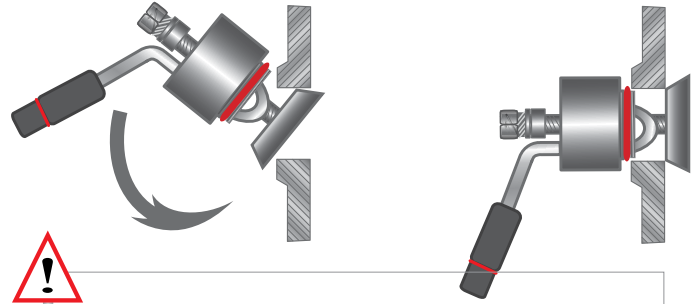

3.5 400 series - Hose heaters

A heater for hose installation is not a universal heater. It may only be installed in the corresponding vehicles in the model list, and in accordance with the procedures in the respective installation manual. This type of heater is used for vehicles which do not have a cap or frost plug in the coolant casing of the engine block. Installation directly in the coolant hoses or another unsuitable spot can lead to the formation of cracks in coolant hoses and leakage of coolant.

The heated part of the element must always be installed so that it is completely surrounded by metal supports and does not touch any combustible parts, such as rubber hoses, etc. The heater must always be installed in a hose that is routed upwards.

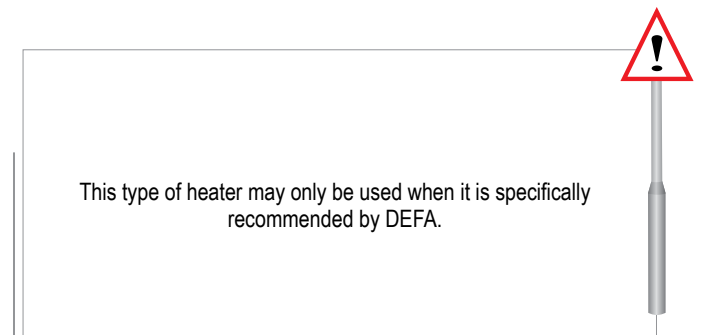
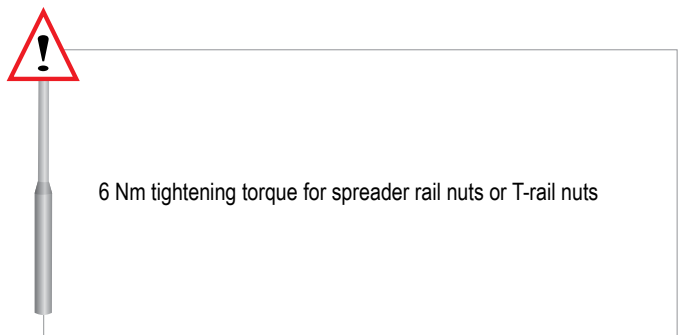
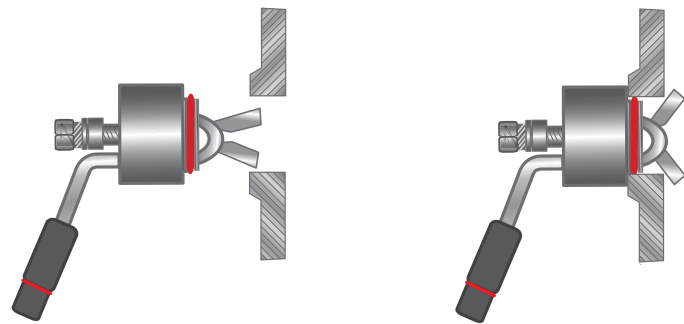

3 - Installation



420-423 - With thermostat

When the element is well protected inside the coolant chamber, in principle, the heating can be installed in various points in the coolant hose. However, the hose must be routed upwards towards the engine and the thermostat for the engine must not be installed in the same hose. The connection box must be installed at the correct angle as specified in the installation manual and at least within the prescribed pitch inside the hose. Otherwise, the heated part of the element in the heater will be in an air pocket and the heater will burn out.

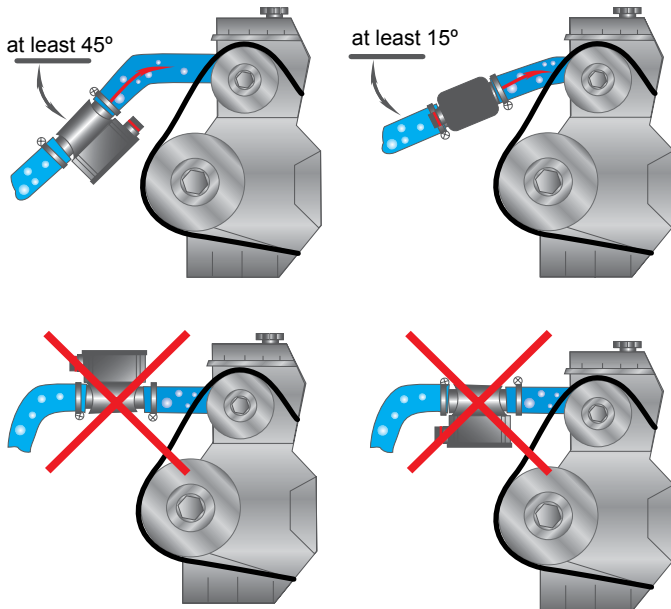

3.6 500 series - Special fastener

Remove the respective cap/frost plug and clean the fitting surface for gaskets and O-rings before installing the engine heating element. Make sure that the PlugIn contact on the heater is pointing in the right direction as indicated in the installation manual.

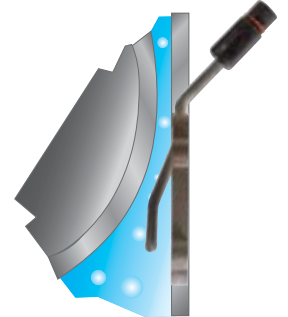

3.7 600 series - Oil heaters

These heaters are used in vehicles which have a cap on the oil pan. The original cap is replaced with a new cap with a cast-in heating element. Oil heaters which are installed directly in the oil pan are installed in the existing threaded hole. As an alternative, a hole can be drilled in the oil pan and the heater can be installed in this hole. Please carefully observe the installation manual for this procedure. If a hole must be drilled, use the drilling template in the installation manual and observe the instructions for the drilling procedure and hole diameter.



Heaters 420-423 may only be installed at the spots in the respective vehicles as specified in the installation manual.

The heater may only be installed in a hose that is routed upwards.

3 - Installation



3.8 700 series - Hose heaters

Hose quality

In order to guarantee optimum quality, hoses from DEFA are carefully inspected and are only selected after undergoing comprehensive testing in our test laboratory. If hoses which deviate from DEFA quality standards are used, they will dry out, form cracks and allow coolant to leak out after a certain amount of time.

3.8.1 701-709 - Without thermostat

These heaters are installed separately or together with a mounting kit.

See the installation manual for the respective vehicle for more information on this.

Important notes:

These heaters must be installed at the lowest possible point.

The element plate must always face downward (I).

The hoses must rise evenly (I).

The heater may not be installed in a horizontal position (II).

The hoses may not be bent too sharply (III).

The hoses may not be unnecessarily long.

The hoses may not touch hot/moving parts, such as turbochargers, exhaust systems, fans, etc.

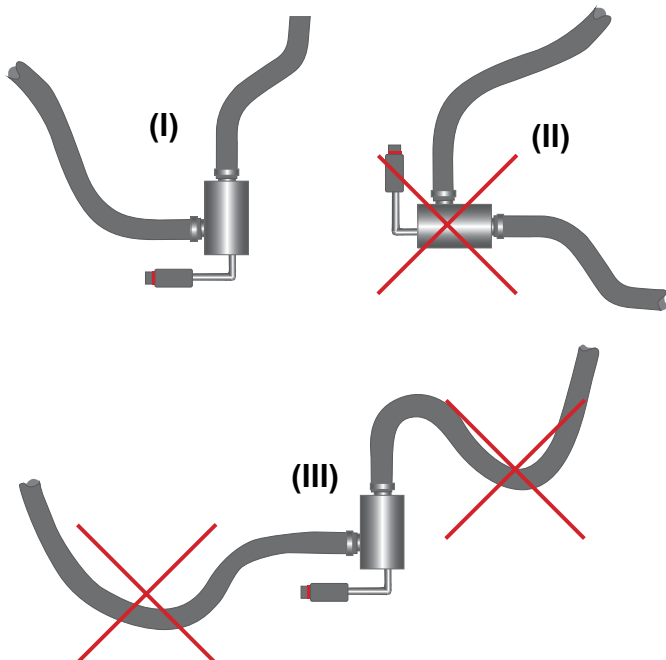

3.8.2 715 - With thermostat

These heaters are installed separately or together with a mounting kit.

See the installation manual for the respective vehicle for more information on this.

Important notes:

These heaters must be installed at the lowest possible point.

The connection box must always face downward (I).

The hoses must rise evenly (I).

The heater may not be installed in a horizontal position (II).

The hoses may not be bent too sharply (III).

The hoses may not be unnecessarily long.

The hoses may not touch hot/moving parts, such as turbochargers, exhaust systems, fans, etc.

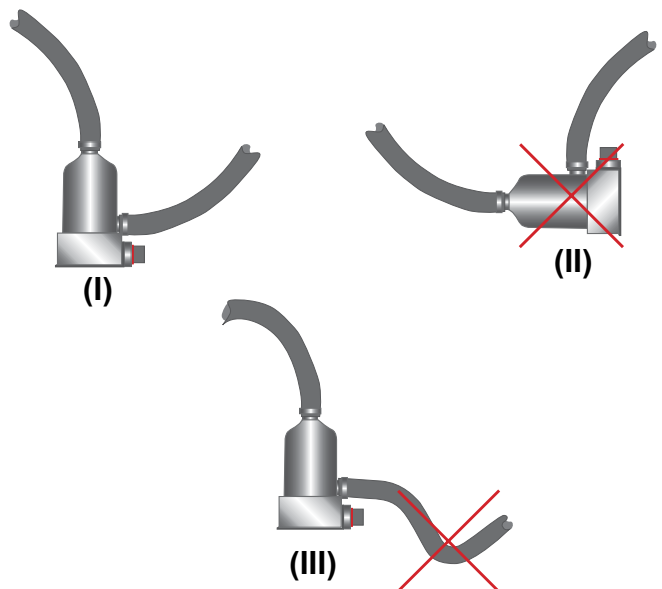

The engine heater may ONLY be installed at the spots in the respective vehicles as specified in the installation manual.
The heater may only be installed in a hose that is routed upwards.



3 - Installation



3.8.3 721-734 Heaters with thermostat

When installing this type of heater, the heater must be level and the embossed arrow must point upward. If the heater is not installed in a level position, this can cause the element to burn out on the top side. This can also occur without the thermal fuses being blown, since an air pocket can form without the temperature rising in the metal plate on which the thermostat and the thermal fuses measure the temperature.

The heater must be installed at the lowest possible point and the cold coolant intake must be the lowest connection point (e.g. drainage cock for the coolant). The warm coolant output must be connected to a high point on the engine (e.g. to the return hose from the heater). The outlet hose must rise evenly up to the highest connection point in order to ensure maximum flow.

Avoid bending the hose downward, as this causes air bubbles to form and will blow the thermal fuses as a result of the heater overheating. A mounting kit is used to make the connections with the engine cooling system.

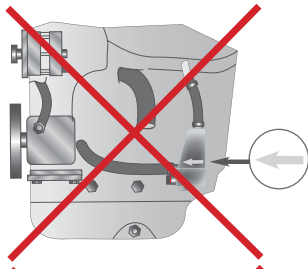
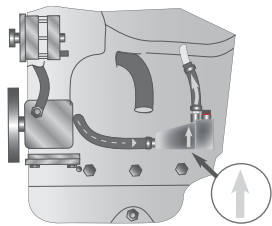

3.9 800 series - Contact heaters

It is imperative that the fitting surface on the engine is thoroughly cleaned before the heater is installed. Remove any burrs, if necessary, in order to ensure optimum contact between the engine block and the heater. Apply Heat Zinc to the fitting surface on the heater. The engine heater is secured with a bolt or holder as specified in the respective installation manual.

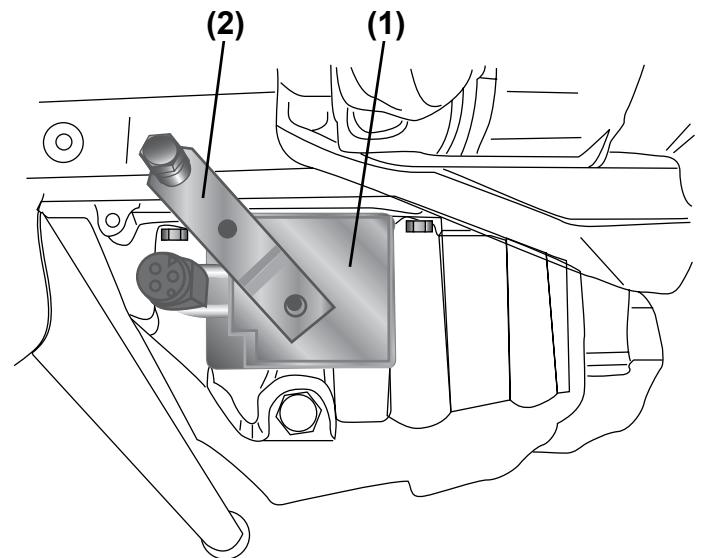

Example of a contact heater (1), installed on the oil pan and fastened with a holder (2)



There is an arrow on heaters 721-734 which indicates the direction of circulation. Warm water rises and cold water sinks.

Improper installation can prevent water from being circulated and cause the thermostat to open. The thermal fuses will blow and the element will burn out.



Check the heater for a secure fit. The heater may not touch hoses, cables and the like.

3 - Installation



3.10 Feed through in the vehicle interior

On many vehicle models, the manufacturers have left openings in the bulkhead in order to accommodate the feed through of accessories. In many cases, these openings can be used to feed through the DEFA extension cable to the interior heater. Use the specially designed tool from DEFA for this. Carefully seal the area around the cables with a suitable packing compound. Some vehicle models have openings which are suitable for feeding cables through from the engine compartment into the interior through the interior trim along the A-pillar of the vehicle. In this case, the plastic interior trim must be removed.

If it is necessary to drill a hole in the firewall of the vehicle in order to feed through the DEFA extension cable into the interior of the vehicle from the engine compartment, extreme caution must be exercised. No holes may be drilled in double sheeting or reinforcements.

The DEFA hole saw (\varnothing 20 mm) is ideal for this task.

It is extremely important to ensure that the tool will not damage any installed components, brake lines, cables, etc. The supplied rubber bushing is used to seal the area around the cable.

When installing the bushing, make sure that it is properly seated. Otherwise, water may be able to penetrate the interior of the vehicle.

Before the extension cable is fed through, make sure it is routed at a downward angle in the engine compartment ① so that no water runs into the interior of the vehicle ②.

Extension cables

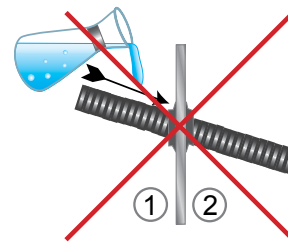
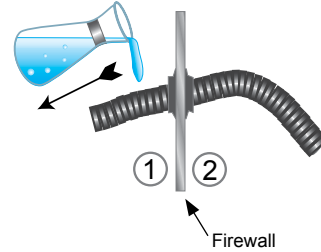

Termini™ extension cable

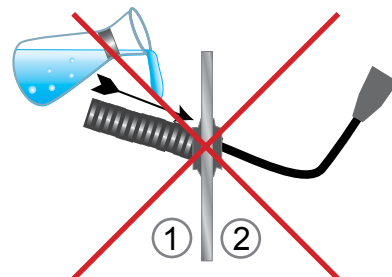
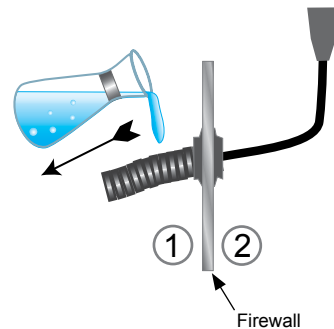

When drilling holes in the firewall, it is imperative to make sure that the tool will not damage any installed components, brake lines, cables, etc. No holes may be drilled in double sheeting or reinforcements. Apply a suitable rust protection coating around the hole.

3 - Installation



3.11 INTERIOR HEATERS

- Termini™ / Termina

The cable must be handled as carefully as possible and the cable insulation may not be damaged by doors, bonnet locks or other sharp objects. Only original DEFA connection accessories may be used with the original DEFA device terminal. The cable may only be connected with an earthed plug.



The interior heater may NOT be covered up. The interior heater must be permanently installed in order to ensure the highest level of safety.

3.11.1 Termini™

DEFA Termini™ is designed for permanent installation in the interior of the vehicle. Termini™ can also be installed in the bottom of the glove compartment (IIIb), on the centre console or on the A-pillar. The discharge opening may not be positioned face down (IIIc). Termini™ must be installed so that sufficient spacing is maintained. The holder (II) is designed so that it can also be installed on uneven surfaces. Remove the holder from the underside of Termini™ by pushing it towards the back. Install the holder with the spacer sleeves (II-A) in the centre of the holder (II). Select the three most suitable holes in the holder and fasten the holder with the three bolts supplied. The attachment points should be as far apart as possible. Use the enclosed drilling template. DEFA always recommends the permanent installation of Termini™.



Drawing I shows the necessary spacing requirements for the finished installation of Termini™. Drawing III shows the correct position of Termini™ in the interior of the vehicle.

(I)

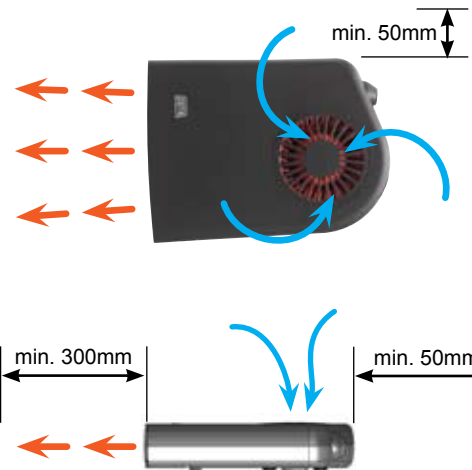

(II)

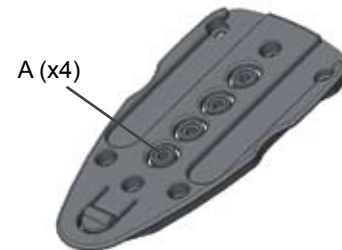

(III)

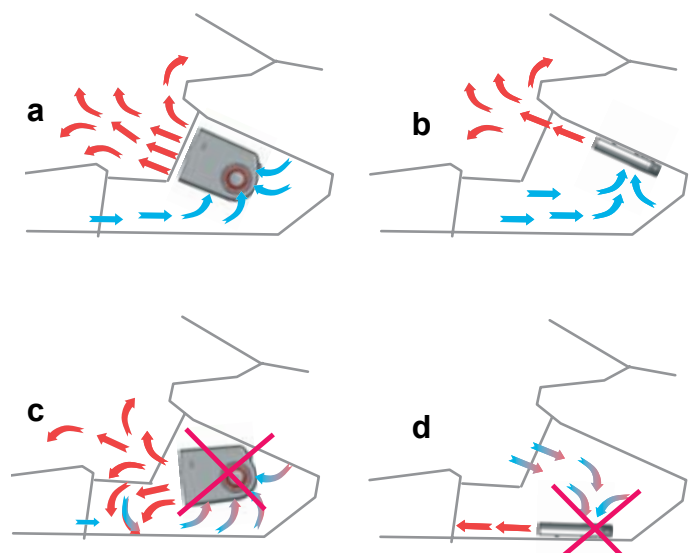

When drilling holes and installing screws to fasten the interior heater, always make sure that no cables or other electrical components underneath will be damaged.

3 - Installation



3.11.2 Termina

The interior heater must be installed with the enclosed holder in a suitable spot in the interior of the vehicle. The illustrations for the instructions apply for 1400W and 2000W interior heaters from DEFA, and show the safety spacing requirements for the interior heaters.



The interior heater must be installed in such a way, that it does not pose a safety hazard in case of an accident or abrupt braking.

When drilling holes and installing screws to mount the holder, always make sure that no cables or time-program controllers on the back of the wall will be damaged.

The interior heater can be installed in the following positions:

Down below, under the glove compartment for example.

On the side panels, on the centre console or on the A-pillar. The discharge opening may not be positioned face down. The interior heater must be installed so that sufficient spacing is maintained. Spacing requirements for the interior heater are shown in the illustration.

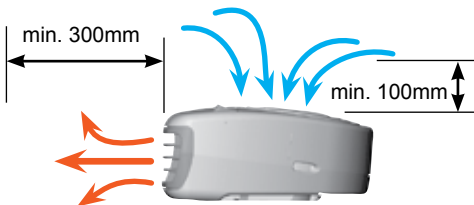
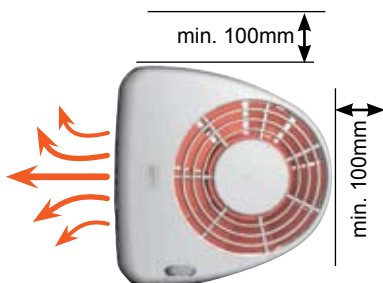

In order to ensure that the vehicle is heated as efficiently as possible, the flow of heat into the interior should not be obstructed by seats or other obstacles. See the illustration for more on this. Circulating air will compromise the heating process. For this reason, it is important to ensure that the air flows past the seats. See drawing III on the previous page for more on this.

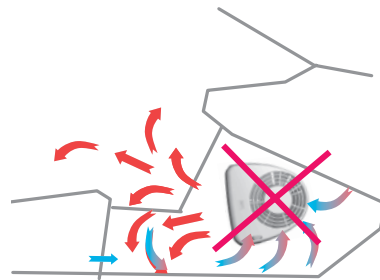
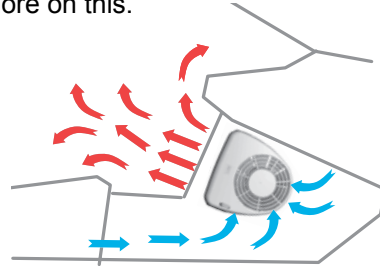

The holder is designed so that it can also be installed on uneven surfaces. The holder is to be installed (see illustration) with the enclosed spacer sleeves ①. Any of the holes in the holder can be used, however, we do recommend that the fastening points are spaced as far apart as possible. The holder is fastened with the enclosed bolts. The spacer sleeves ① must be removed before the holder is installed. The interior heater is guided into the holder ② until it you hear it click in place.

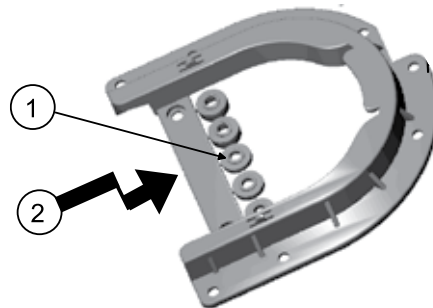

DEFA interior heaters are based on PTC technology, in which the output is regulated by the temperature. This means that maximum heat output is delivered at -25°C , when the demand is greatest. As the interior temperature increases, output is decreased.

3 - Installation



3.12 BATTERYCHARGER - MultiCharger

DEFA battery chargers are suitable for installation in the engine compartment or, for example, on an HGV chassis. The chargers are easy to install, and they ensure that the battery is always fully charged.

DEFA battery chargers are constructed and tested in accordance with EN 60335-2-29.

Alternatively, the positive cable can be connected to the positive terminal on the starter. This also applies for 12 V systems. The cross section of the cable between the starter and battery is large enough that voltage drop does not need to be taken into account. If the 12 V cable must be extended, the installed cable is to be removed and replaced with a thicker cable with a larger cross section. As a rule of thumb, if the length of the cable is doubled, the cross section should also be doubled. See the technical data for more information.



MultiCharger 1203



MultiCharger 1210



The charging of batteries in poorly ventilated spaces must be avoided due to the risk of explosion. The charger must be installed with the drainage hole facing down, i.e. the white arrow on the label must point upwards.

The temperature of the battery may not exceed +40°C while charging.

Avoid explosive gases, flames and sparks.

Switch off the mains supply before disconnecting the DC voltage connection. Red cable to positive terminal via fuse, black cable to negative terminal. To interrupt the charging process, the mains supply (230V) is disconnected (i.e. negative terminal first, then the positive terminal).

Do not shorten or extend the cables (12V), as this cause incorrect charging voltages.

The charger must be correctly installed in order for water to drain. The direction is indicated on the label on the charger and/or on the top side of the charger.

3 - Installation



Multicharger 1203

The battery charger is to be connected according to the circuit diagram in section 3.15. The enclosed fuse must be used to connect the charger to the battery. The enclosed holder can be used to simplify the attachment of the battery charger.

Route the cables onto the contacts on the battery charger **(1)** so that they are straight, in order to prevent the PlugIn contacts from being bent or twisted **(2)**.

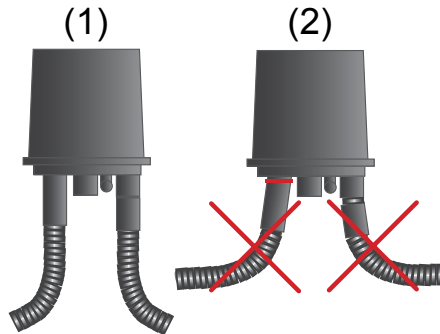

Make sure that the battery charger is not installed too close to hot parts, such as exhaust manifolds, turbo chargers and the like. Sufficient spacing must be maintained between the charger and moveable parts, such as belt pulleys, fans and steering rods.

Multicharger 1210

The battery charger must be installed on a straight, vertical surface. Route the cables onto the contacts so that they are straight, in order to prevent the PlugIn contacts from being bent or twisted. The bottom fixing tabs have two slots which allow condensation to drain from inside the charger. The charger must be installed in a vertical position so that the slots face downwards for drainage.

12V systems

The charger is fastened at three of the four attachment points. Always use both of the side attachment points and either the top or bottom attachment point. Use the enclosed spacer discs on both sides to create a straight mounting surface.

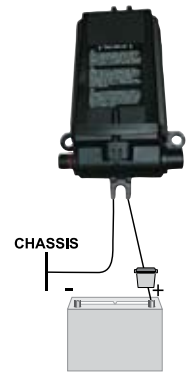

24V systems

In order to charge a 24V system, two 12V chargers have to be used. Two chargers can be connected directly on the 230V side. However, it is also possible to connect the chargers with an extension cable after installing both of them in their respective positions.

If two chargers are connected without an extension cable, the enclosed metal sleeve **(1)** must be used to secure the chargers in the common centre fastening point.

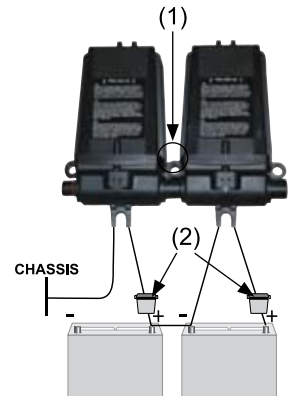

In doing so, make sure that the connection of the chargers is secure, that they are aligned one in front of the other and that the cables are not twisted. Use all of the fastening points in the centre and both points at the top and bottom. Each charger must be protected with a fuse **(2)** and connected with the respective battery. The 12V outputs on the chargers may not be connected in series.



The MultiCharger cable (200 cm) between the fuse holder and battery may not be shortened. If the cable has to be extended, the cross section must also be enlarged.

Double the length = double the cross section

3 - Installation



SmartStart™ 24V

Observe circuit diagram **D20** during the installation. Use the enclosed cable terminals.

The VU must be installed in a vertical position. The cables are connected from below. The enclosed fastening strips are used to secure the unit.

D* Blue: Only required for the remote control of a fuel heater. For an electric vehicle heating system, the ignition signal is recognised when the voltage drops when the vehicle is started.

A - The end of the antenna **MAY NOT** be installed in the engine compartment. The end must be spaced at least 10 mm away from any metal. One suitable installation point, for example, is on outside of the vehicle in the seal between the windscreen and the bodywork.

C** Separate control of the interior heater. Requires an additional relay.

REMOTE CONTROL OF THE FUEL HEATER

B*** -The white cable is connected to the analog control input on the fuel heater. Refer to the specifications of your fuel heater.

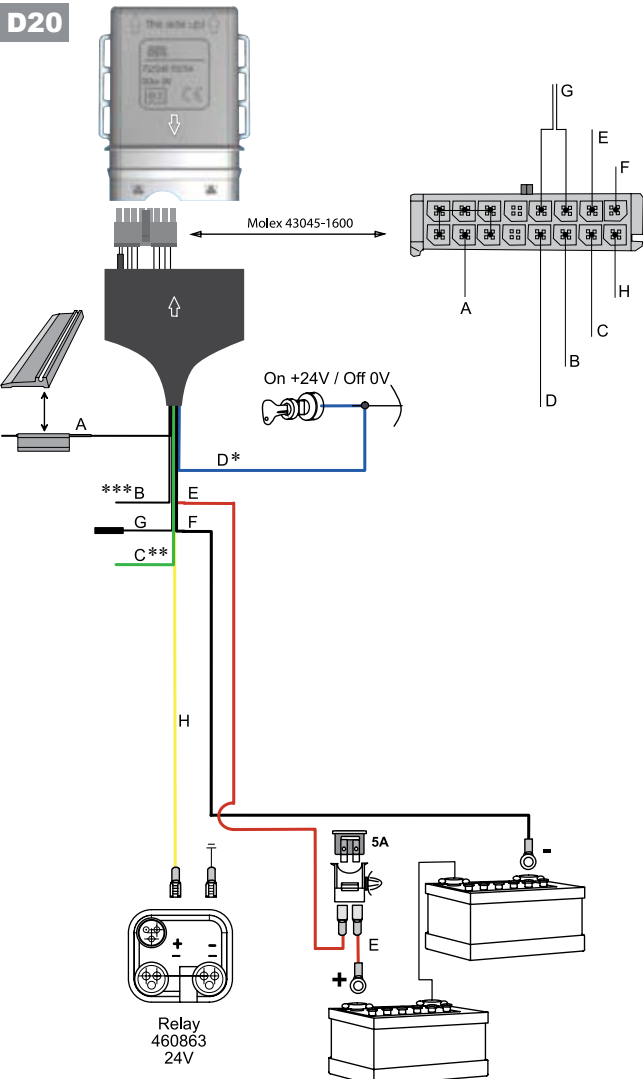

After SmartStart™ has been installed and connected, proceed as follows:

1. Activate the battery by removing the yellow plastic insulation. SmartStart™.
2. Activate the remote control by pressing the button on the right-hand side of the unit.
3. The units have already been synchronised at the factory. Press the **Mode** button on the right-hand side. The remote control establishes contact with the vehicle unit and accesses information contained in it.
4. Set the time, date and language as instructed in the quick start guide.
5. Press the right button to return to the output menu with the next departure time.

The complete operating manual is contained in the mini-CD which is enclosed with SmartStart™ and it can also be accessed on our website (www.defa.com) under SmartStart™.



Fuel heater control provides access to an analogue signal from the fuel based pre-heater. Refer to the circuit diagram for your fuel heater.

3 - Installation



Futura

- Look for a suitable installation point for the control unit in the interior of the vehicle on the dashboard or on the centre console. If the customer wants to operate DEFA WarmUp using time-program control alone, the device can be installed on the sun visor inside the vehicle.
- Carefully clean the surface with suitable grease solvent (e.g. Acrysol). Do not use acetone, Tri, Breakclean and the like, as they can damage PVC and other types of plastic. The time-program controller is secured with the enclosed double-sided tape.
- The cable is connected to the controller at the contact under the small cover. The cover is opened as shown in the illustration.

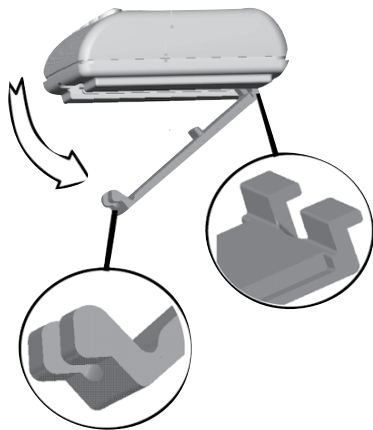

The plug ① is installed with the red cable arranged as shown in the illustration. When the lid is closed, the thin part ② must be in the opening and the thick part ③ must be in the inside. This relieves strain on the cable and prevents it from being pulled out.

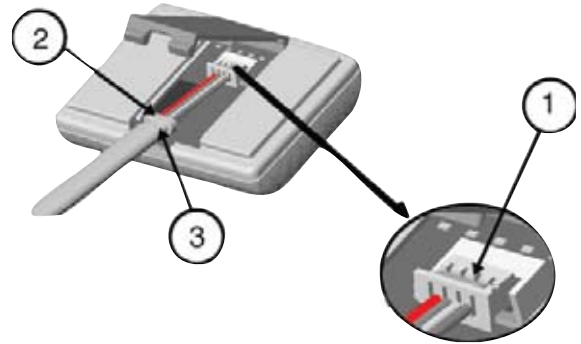

Install the outside temperature sensor. This sensor serves two purposes:

- Temperature-controlled activation of DEFA WarmUp
- Black ice warning and outside thermometer, when the vehicle is in operation (+/- 4°C).

The temperature sensor must be arranged so that it will not be affected by hot parts such as the engine, radiator, exhaust system, etc. One such suitable spot is behind the bumper, or alternatively, in another spot on the front of the vehicle that is protected from splash water and mechanical interference.

If the outside temperature sensor is not installed, the functions for the display of battery voltage, black ice warnings and outside temperature will not be available. The internal temperature sensor in the time-program controller will be used for the automatic control of the activation times.

The cable for the time-program controller and battery charger is supplied as a single unit. This simplifies connection of the units.



The cover is different at each end.
It can only be opened from the switch side.

3 - Installation



Futura

The cable for the timer **D21** is connected as follows:

Red: The red cable is connected, via the fuse, to the blade terminal marked with + on the battery charger/relay box and to the +12V terminal on the battery. Alternatively, the cable can also be connected to the positive terminal of the starter.

Black: The black cable is connected to the blade terminal marked with - on the battery charger/relay box and to the chassis.

Yellow: The yellow cable is connected to the blade terminal marked with the ⚙️ symbol on the battery charger/relay box.

Green: The green cable is for the temperature sensor and it is connected to the wiring harness.

Blue: The blue cable is connected to the ignition in the vehicle's fuse box or to the ignition lock; 12V = ignition **ON**, 0 V = ignition **OFF**.

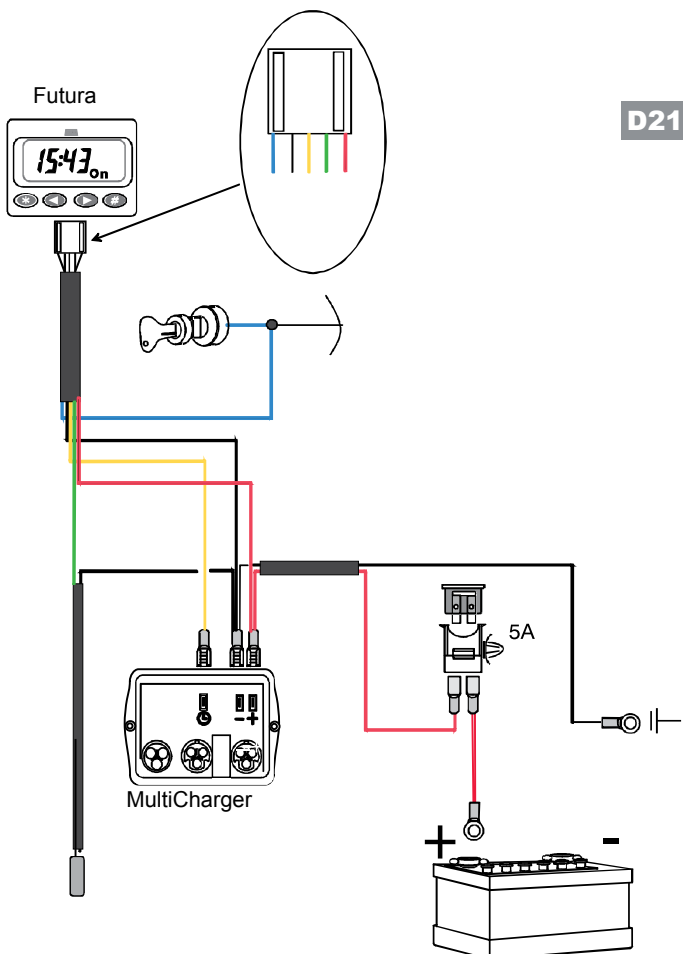

3.14 CONNECTION ACCESSORIES

Connection cable

The connection cable must be handled as carefully as possible and it may not be damaged by doors or bonnet locks. No sharp objects may press against the cable, otherwise the insulation may be damaged.

The safety cap should always be kept on the contact when it is not in connected.



The safety cap should ALWAYS be kept on the contact when it is not connected. A replacement cap can be ordered through a DEFA dealer (item no. 418063). Only original DEFA connection cables may be used with the original DEFA device terminal. The cable may only be connected with an earthed plug.

The cable must be unplugged from the wall socket and from the vehicle's EcoPlug when DEFA WarmUp is not in use.

DEFA MiniPlug

There are two options for installing DEFA MiniPlug:

- Flush in the front or on the bodywork of the vehicle
- Mounted on the holder in existing receptacles on the front of the vehicle

All of the installation accessories are included in the scope of delivery of DEFA WarmUp. The enclosed holder can be positioned in several different ways to facilitate a functional arrangement. Upon request, the contact can be painted in the colour of the vehicle, thus making it virtually invisible when flush mounted.



3 - Installation



The device connector must be installed outside of the interior, in a place where it will be protected from splash water and mechanical damage.

If at all possible, the contact should be mounted so that the front side faces downward at an angle.

If the contact is mounted so that the front side faces upward at an angle, the lowest of three dampers will have to be opened for drainage (see drainage on the following page). This applies for installation on the holder and for flush mounting.



The earth connection (black cable with ring terminal) must be connected to a bare metal part of the bodywork. Paint and the like must be removed from the attachment point for the earthing cable.

DEFA MiniPlug with holder

Depending on the installation point, the holder can be mounted on both sides. The contact can be adjusted and turned in order to achieve the desired position. The contact is normally installed with the lid hinge at the top. However, it can also be installed with the lid hinge to the side. The contact may **NOT** be installed with the lid hinge at the bottom.



Flush installation of DEFA MiniPlug

DEFA MiniPlug must be installed in such a way that it is protected from splash water and mechanical damage, and so that the connection cable can be easily connected.

If the fitting surface is not level for the fastening nut, the enclosed installation ring must be used. If used, the O-ring is inserted in the groove in the plastic nut or installation ring.

For flush installation, a hole with a diameter of 24.5 mm is drilled and a guide slot with a diameter of 3 mm is filed. Use the special tool from DEFA for this. Make sure that there is enough space on the back side for the cable and the fastening nut. Proceed with extreme caution in order to avoid damaging installed components, cables and the like.

Drainage

Regardless of whether DEFA MiniPlug is installed flush or with a holder, the contact should always be installed to the lid at a downward angle so that water (condensation) can drain.

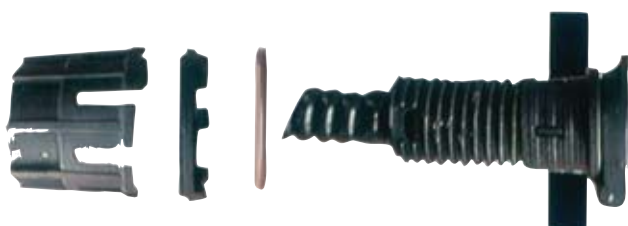
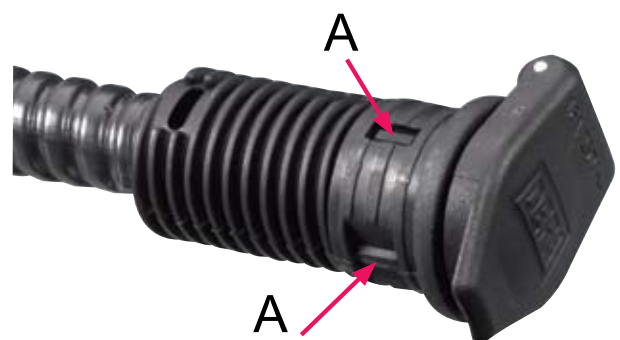

If the contact is installed at an upward angle, the lowest of three dampers **MUST** be opened for drainage A. (Do not press the plastic piece into the contact.) A knife can be used for this.

3 - Installation



Earthing

The earth connection (black, single-phase cable with toothed ring terminal) **MUST** be connected to a suitable earthing point on a bare metal part of the vehicle's bodywork. Paint, primer and the like **MUST** be removed from the connection point for the earthing cable.

Only original DEFA connection cables may be used with the original DEFA device terminal. The connection may only be made with an earthed plug.

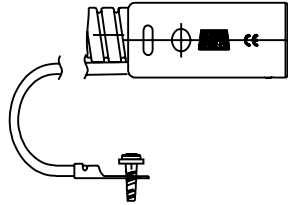

DEFA plug connections and extension cables

The PlugIn system makes it easy to connect the main components of DEFA WarmUp and extension cables. The plug connectors are designed so that they cannot be plugged-in incorrectly, and to ensure a safe and secure connection.

When making connections, the contacts must be pressed together firmly enough to ensure that the o-ring will sufficiently seal the plug contact. Make sure that the o-ring does not slip out of the groove when the contacts are pressed together.

The extension cables are fastened to suitable points in the engine compartment of the vehicle with ample spacing between them and moving parts such as belt pulleys, fans, etc.

Make sure that the extension cables are not routed too close to hot parts, such as exhaust manifolds, turbochargers and the like. Cable connections may not be subjected to stress from twisting or bending.

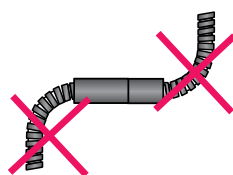
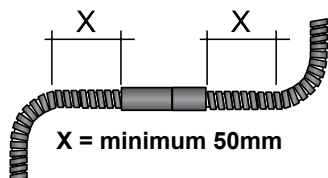

Do not route cables under the engine and/or where they will be near engine parts that rotate or move, or near the drive train.

Termini™ interior heater contact junction

Used as a junction if Termini™ with an interior heater contact already exists and you would like a connection at a normal socket or **460829**.



Interior heater contact 460829

This contact may only be used in the interior of the vehicle. It is only protected to IP20 and thus may not be installed in the engine compartment, etc. It is also important to note that the contact is approved for a max. of 10 A.



Y-connector 460853

Completely sealed connector for junctions (e.g. for interior heater set, etc.), IP44. Contains contact rails only (i.e. secure electrical connections).



90 T-connector 460831

Connector for junctions (e.g. for interior heater set, etc.), IP44. Contains contact rails only (i.e. secure electrical connections).



DEFA relay 460838 (12V)

Refer to circuit diagram in the enclosed fitting instructions for DEFA relay for use with SmartStart™ or Futura timer.



DEFA relay 460863 (24V)

Refer to circuit diagram in the enclosed fitting instructions for DEFA relay for use with SmartStart™ or Futura timer.



3 - Installation



3.15 CIRCUIT DIAGRAM - WarmUp

3.15.1 SmartStart™ / Termini™

D22

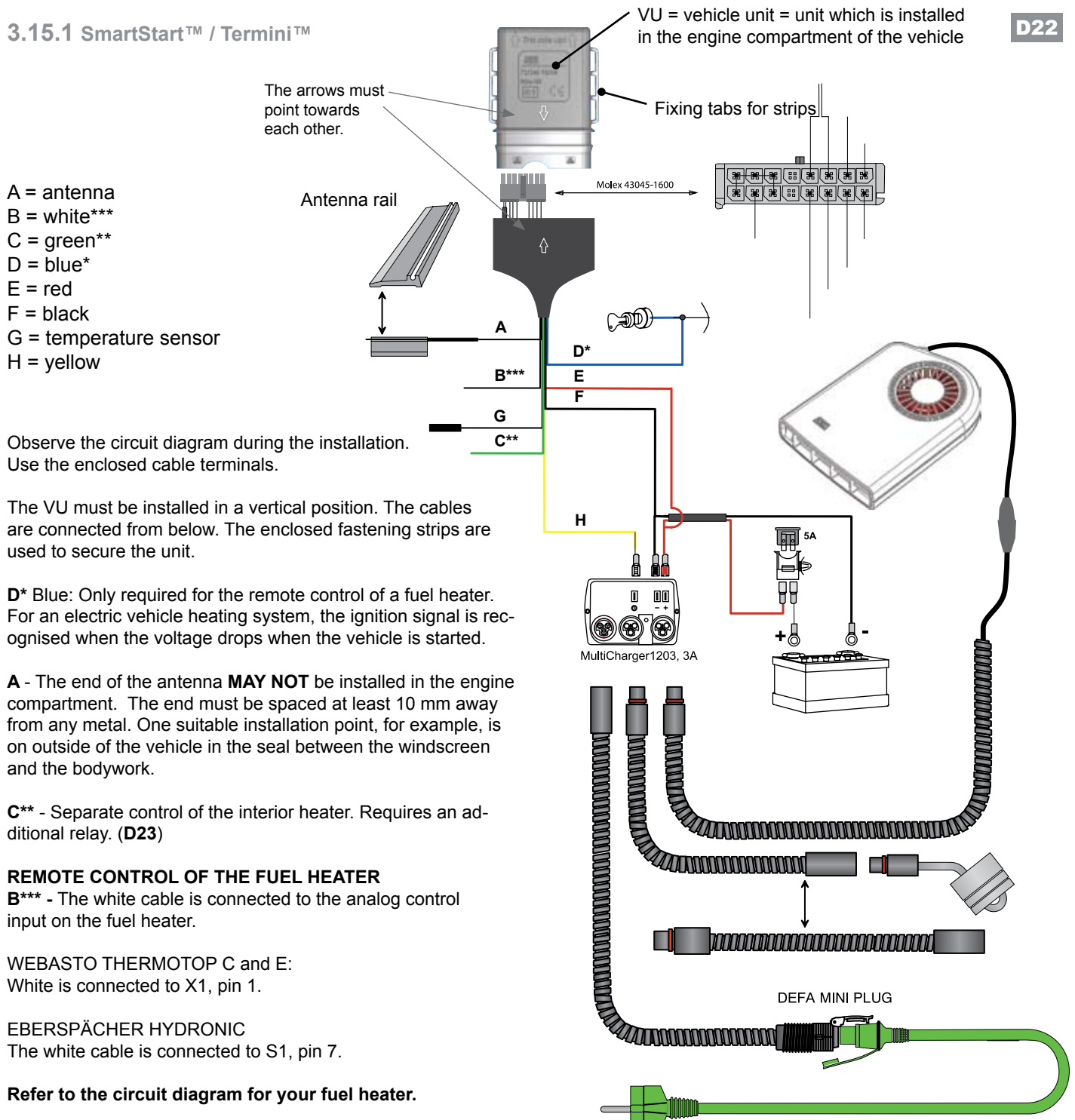

The MultiCharger cable between charger and battery MAY NOT be shortened.

3 - Installation



3.15.2 SmartStart™ / Termini™ with independently controlled engine heater and interior heater

D23

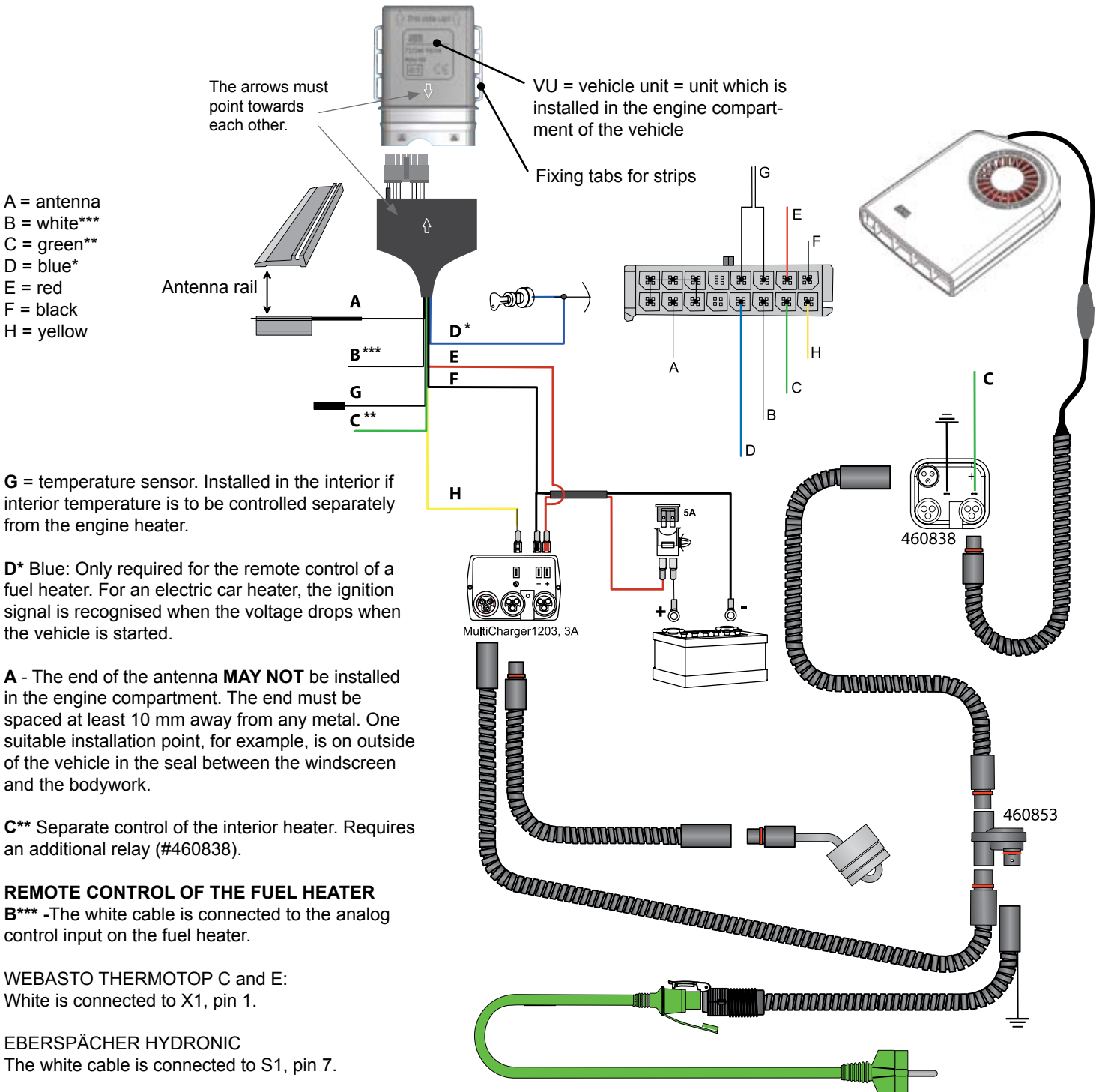

 The MultiCharger cable between charger and battery **MAY NOT** be shorted.

3 - Installation



3.15.3 Futura / Termina

D24

The cable for the timer is connected as follows:

E - Red: The red cable is connected, via the fuse, to the blade terminal marked with + on the battery charger/relay box and to the +12V terminal on the battery. Alternatively, the cable can also be connected to the positive terminal of the starter.

F - Black: The black cable is connected to the blade terminal marked with - on the battery charger/relay box and to the chassis.

H - Yellow: The yellow cable is connected to the blade terminal marked with the ⚙️ symbol on the battery charger/relay box.

C - Green: The green cable is for the temperature sensor and it is connected to the wiring harness.

D - Blue: The blue cable is connected to the ignition in the vehicle's fuse box or to the ignition lock; 12V = ignition **ON**, 0 V = ignition **OFF**.

T - Temperature sensor: Place the sensor in the front of the vehicle shielded from being influenced by the engines temperature.

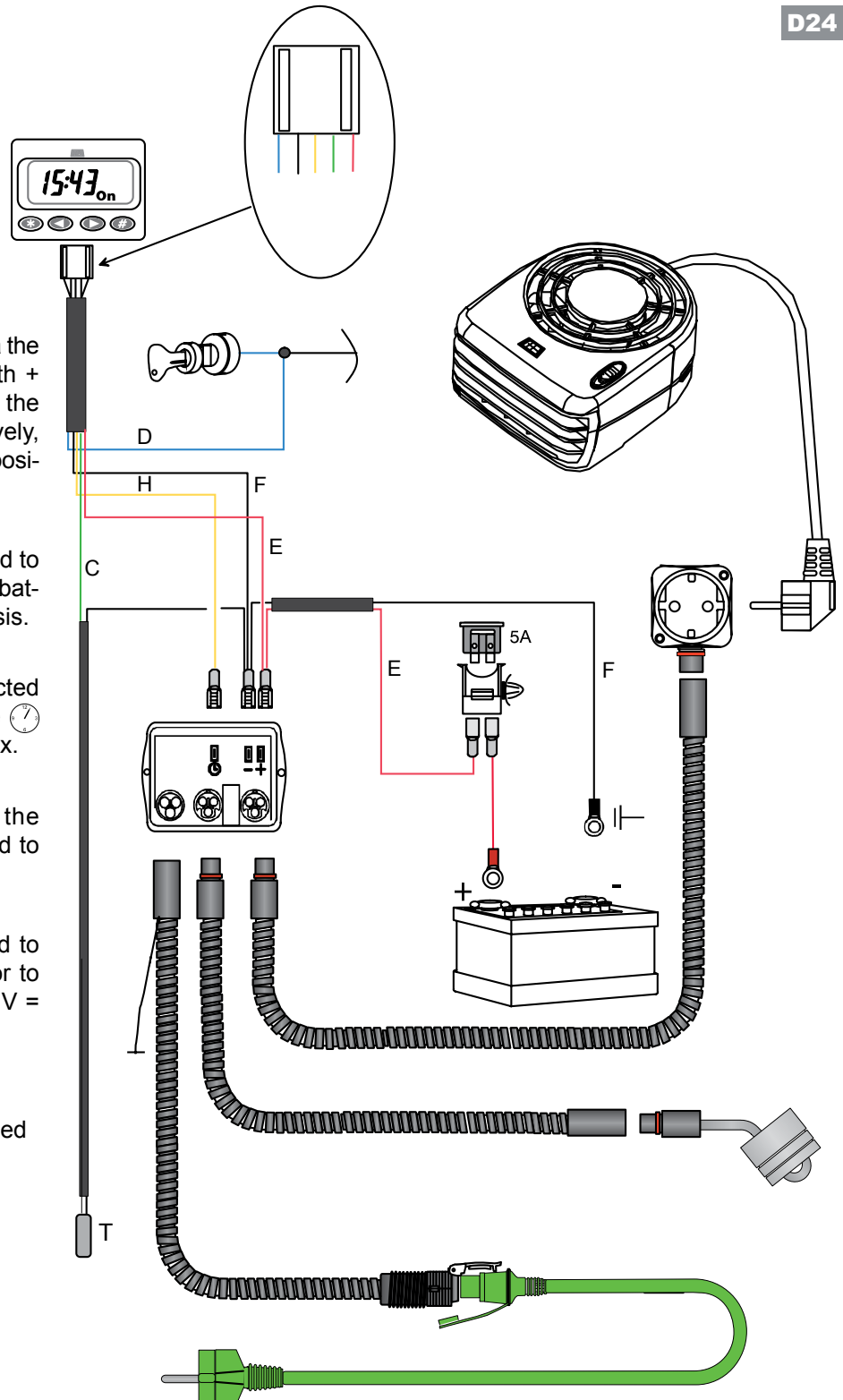

 The MultiCharger cable between charger and battery MAY NOT be shortened.

4 - Support



This chapter covers troubleshooting. Before any further action is taken, two important things must be checked:

1. Is voltage present at the contact which WarmUp is connected to? If the fuse is blown, verify whether or not the circuit is laid out for the overall current drain.
2. Check the settings in the time-program controller.

The tables on the following pages contain causes and remedies to rectify simple faults which may occur with DEFA WarmUp.

DEFA WarmUp

FAULT	CAUSE	REMEDY
Engine is not being heated.	The time-program control is not properly set.	See chapter on the use of time-program control.
	Not enough coolant.	Top off coolant, bleed air out of the system.
	Engine heater improperly installed.	Inspect the engine heating element for damage.
		Inspect according to installation manual.
	The engine heating element is defective.	Check the element with an ohmmeter or tester for engine heaters.
The blue cable on the time-program controller is not properly connected.	Check the connection of the blue cable on the controller.	
The engine heater generates heat, but the engine is cold.	Installation error.	Inspect heater position according to installation manual.
	No circulation in the cooling system.	Bleed air out of cooling system according to manufacturer's instructions.
	Air in cooling system.	Bleed air out of cooling system according to manufacturer's instructions.

4.1 ENGINE HEATER

For troubleshooting problems with engine heaters, we recommend the use of an ohmmeter and/or a tester from DEFA for engine heaters. The tables contain the measurement values of an engine heater in Ohms.

Power [W]	Approx. Ohms
250	211
300	176
600	88
750	70
820	64
1000	52
1500	35
2000	26

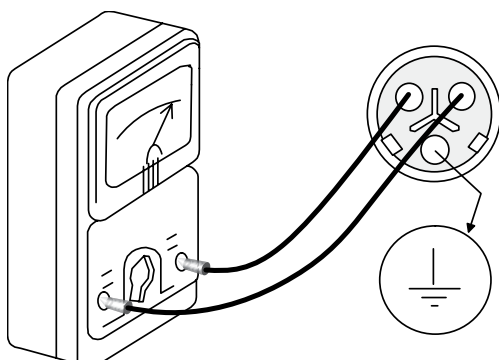

Tester for engine heater elements with connection for DEFA EcoPlug. Order number: **490265**

4 - Support



The illustrations exemplarily show engine heater elements which are returned for replacement and are to serve as a guideline for dealers. The cause of engine heater failures can usually be determined by inspecting the surface of the engine heater elements.

Legitimate complaint

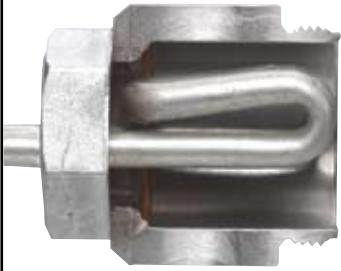
	FAULT	CAUSE	REMEDY
	Clean and untarnished element	Manufacturing defect	Return engine heater as per the replacement agreement.

Complaint is investigated

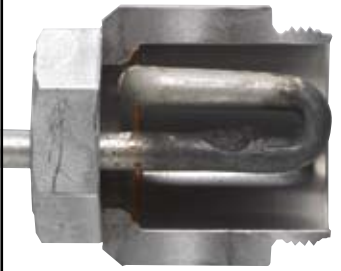
	FAULT	CAUSE	REMEDY
	Element or element parts are bluish-black	Insufficient cooling of the element due to: 1. Installation error (see installation manual) 2. Cooling system not properly bled off 3. Not enough coolant in engine 4. Impaired circulation of coolant around the element	Install according to installation manual. Bleed air from cooling system, allow engine to run until warm and top off with approved coolant before connecting the engine heater element. (Inspect for coolant leaks.)

Unwarranted complaint

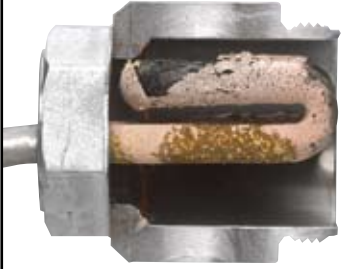
	FAULT	CAUSE	REMEDY
	Film/deposits on element tubes (if in doubt, scratch with a knife)	Dirty or contaminated coolant (see installation instructions)	Clean cooling system and refill with fresh, approved coolant.

4 - Support



4.2 INTERIOR HEATER

FAULT	CAUSE	REMEDY
The vehicle interior is cold. The interior heater does not work.	The automatic overheating circuit breaker switched off the interior heater.	Disconnect the electrical contact for the interior heater. Wait 30 minutes, then reconnect the contact.
	The SmartStart™ or Futura time-program control is improperly set.	See chapter 3 "Time-program control" to troubleshoot.
	A fault has occurred in the interior heater fan.	Return the interior heater to your dealer/supplier.

4.3 BATTERY CHARGER

4.3.1 MultiCharger 1203. 3A

FAULT	CAUSE	REMEDY
The charge indicator lamp on the top of the battery charger does not light up.	The charger has switched into trickle charge mode.	This is normal when the charger has been connected for an hour and the battery is fully charged.
The battery charger does not work.	The fuse between the charger and battery has blown.	Inspect for possible faults and replace the fuses.
The charger only works in quick charge mode (green/red LED).	Short circuit in a cell.	Check acid level (approx. 1 if defective), replace battery.

4.3.2 MultiCharger 1210. 10A

FAULT	CAUSE	REMEDY
The charger starts the charging process in trickle charge mode (green LED).	Fuse has blown.	Replace fuse.
	Broken cable.	Inspect cable.
The charger only works in quick charge mode (red LED).	Cell short circuit	Check acid level (approx. 1 if defective), replace battery.

4 - Support



4.4 TIMER

4.4.1 SmartStart™

FAULT	CAUSE	REMEDY
The display indicates that the battery needs to be replaced. But the battery was just replaced!	When SmartStart™ is exposed to low temperatures, the display will prompt the user to replace the battery even if the battery has just been replaced.	Warms-up SmartStart™ to room temperature.
	Check to make sure that the prescribed lithium battery has been used.	Install lithium battery. DURACELL 28L or SANYO 2CR- 1/3N
No contact with the vehicle.	Antenna installation error	Check to make sure the antenna is installed according to the instructions.
SmartStart™ does not start the vehicle heating system as expected.	Date and time set incorrectly.	Observe the instructions in the SmartStart™ operating manual for setting the time and date.
	Wrong weekly program selected.	Observe the instructions in the SmartStart™ operating manual for setting a five- or seven-day week.
	Date-controlled activation time is active.	Observe the instructions for deleting the date-controlled activation time in the SmartStart™ operating manual (see "Date-controlled activation time" under the "Heating program" section).

4.4.2 Futura

FAULT	CAUSE	REMEDY
The time-program controller stays dimmed, no indication in the display.	Fuse between the charger and battery has blown.	Inspect for possible faults and replace the fuse.
The display does not light up when the engine is started.	The time-program controller is programmed to keep display lighting switched off while the vehicle is being driven.	See chapter on the use of time-program control.
WarmUp is not activated at the desired departure times.	Departure time set incorrectly.	Rectify fault.
	Time-program controller stays in the OFF position.	
	Time-program control is set to Automatic and the outside temperature is above +10°C.	
	The blue cable is improperly connected.	
Display lighting and digits blink while driving.	Black ice warnings function.	This is normal. Blinking lasts for 6 seconds.
	Temperature between +4 and -4°C.	
WarmUp stays switched on after engine has been switched off, although it is a long time until the next departure time.	The time-program controller normally clears the remaining activation time (and 2 hours with "Oversleep" after the engine has been switched on after the departure time). This is registered by an ignition signal.	+12V must be present at the blue cable when the ignition is on, and 0 V present when the ignition is off.
Time-program controller only works in the ON position.	Blue cable improperly connected.	+12V must be present at the blue cable when the ignition is on, and 0V present when the ignition is off.

4 - Support



4.5 CABLES/CONTACTS

Unwarranted complaint

	FAULT	CAUSE	REMEDY
	<p>The connection cable is no longer straight. The cable is bent.</p>	<p>The connection cable is under tension. Most commonly caused by driving the vehicle after the cable has been connected in such a way that it is under tension.</p>	<p>The connection cable MAY NOT be used. Buy a new cable. Also inspect the device connector (normally on the front of the vehicle) for damage.</p>

Unwarranted complaint

	FAULT	CAUSE	REMEDY
	<p>Broken contact with damaged pins.</p>	<p>Most commonly caused by driving the vehicle after the cable has been connected in such a way that it damages the contacts.</p>	<p>The connection cable MAY NOT be used. Buy a new cable. Also inspect the device connector (normally on the front of the vehicle) for damage.</p>

Unwarranted complaint

	FAULT	CAUSE	REMEDY
	<p>Charred surface between pins or earth.</p>	<p>Leakage current due to moisture, which, for example, can result from the contact being in the snow.</p>	<p>The connection cable MAY NOT be used. Buy a new cable. The socket MUST be replaced.</p>

4 - Support



4.6 COMPLAINTS PROCEDURE

1. INTRODUCTION

This document describes the guidelines for the handling of complaints and the complaints procedure between RD and the dealer. The guidelines are applicable for complaints for DEFA products which are due to material and/or manufacturing defects.

Definitions

- "Dealer" refers to a dealer of products from DEFA Automotive.
- "RD" refers to the regional marketing manager or national marketing manager.
- "End-user" refers to the consumer.

2. COMPLAINTS PROCEDURE AS IT RELATES TO RD AND DEALER

- 2.1. Complaints procedure
- 2.2. Handling defects
- 2.3. Limitation of liability

2.1. Complaints procedure

a) These complaint procedures are applicable for complaints for DEFA products, which are sold to and installed for the end-user, and for which the complaint is processed by the RD through the dealer. The dealer is obligated to process complaints in accordance with the guidelines contained in this document.

b) The dealer must forward complaints which are received from the end-user to the RD, without hesitation, but no more than one week after acceptance. The shipment must contain the allegedly defective products and a brief report which contains the following information:

1. Invoice, receipt of purchase or another valid form of documentation of the date of sale/installation.
2. Name of the owner, address, vehicle type, engine type and model.
3. Documentation which shows that the defective product was installed by an authorised garage.
4. Description of the fault.
5. Returned/defective product.

c) If the complaint is not sent to the RD within the specified period of time or the return shipment is not properly prepared, the right to complain shall be forfeited.

d) The RD must process the complaint and inform the dealer whether or not the complaint is legitimate. There shall be no unnecessary delay in providing the dealer with this information. The dealer shall be informed no more than 2 weeks after the RD has received the shipment as per point b). If the complaint is rejected, the dealer must be informed of the reason for rejection.

e) If defects are found for which DEFA is liable according to point 2.2., the complaint shall be deemed legitimate. If the defective product was installed by an authorised garage, the removal/reinstallation costs will be covered as per the agreement.

2.2. Handling defects

When a dealer submits a complaint in accordance with point 2.1, the following duties apply to the RD:

- a) The warranty for DEFA products is valid for three years from the date of purchase. The date of purchase must be verifiable with a valid receipt.
- b) The complaint must be due to faults or defects caused by material or manufacturing defects, which existed at the time when the product was delivered to the end-user.
- c) The expiration date of the warranty period is based on the date as it appears on the invoice or receipt of purchase.

If the end-user is submitting a claim for consequential damages caused by a DEFA product, the dealer must report this to the RD immediately. The dealer must take precautions to ensure that the object, which is alleged to be the subject of consequential damages, is not manipulated in any way, before DEFA has the opportunity to appraise the damage and determine the cause.

d) The dealer's responsibility is limited to the creation of the required documentation according to the description in this document and the forwarding of complaints, including the required information, to the RD.

e) DEFA's responsibility is limited to the remedy of faults/defects through the repair of the product, or through the provision of a comparable product if necessary, according to what DEFA deems to be appropriate, and does not extend to cover consequential damages.

f) The RD's responsibility is limited to the remedy of faults/defects through the provision of an equivalent replacement product or a product which has been repaired by DEFA, according to what the RD deems to be appropriate, and does not extend to cover consequential damages.

2.3 Exclusions

The claim will be rejected if the fault or defect is attributed to the following causes:

- a) Normal wear or ageing.
- b) DEFA products were connected with third-party products and/or accessories and an appropriate investigation has been conducted. An exception to the rule is SmartStart™.
- c) Installation errors.
- d) Insufficient maintenance/care and improper or unintended use.
- e) The product has been tampered with, modified or repaired, or attempts to do so were made, by persons not affiliated with DEFA, without having first obtained written permission from DEFA to open, modify or repair the product.
- f) Circumstances which are beyond the control of DEFA.

The dealer is not authorised to make statements to third parties on behalf of the RD, by making guarantees, providing descriptions regarding the quality of DEFA products or in any other way, directly or indirectly, unless expressly stated in a previously obtained written consent from the RD.

If there are no local DEFA distributors in your country/region, please contact main office:

DEFA AS - Automotive dept.
Blingsmovn 30
N-3540 Nesbyen, Norway

Phone: +47 32 06 77 00 , Fax: +47 32 06 77 01
www.defa.com



Normal use is - 3 connections for 3 hours pr. 24 hour based upon 150 users days a year (5 months a year).



4.7 CE DOCUMENTATION



DEFA AS

Declaration of Conformity

DEFA AS, 3540 Nesbyen, Norway
 Hereby declares that the following products (produced by DEFA)

1	411001 – 413899(95)	Engine Heaters
2	430008(95), 430009(95), 430014(98), 430020(95), 430022(98), 430010(01), 430012(01), 430017(02), 430023(04), 430050(06), 430051(06), 430060(07), 430061(07)	Interior Heaters
3	450008(95), 450009(98), 450011(03)	Battery Chargers
4	440008(95), 44001001(98),	Timers
4a	44002001(06), 44002002(06), 44002102(06)	RF Timers
5	460802(95)*, 460803(95)*, 460843(95)*, 460804(95)*, 460809(95)* 460801(95), 460820(95), 460839(95)*, 460901(95)#, 460915(95)#, 460939(95)# 460920(95)***, 460921(95)***, 460924(95)***, 460860(06), 418069(06)	Cables
6	460838(97), 460828(97), 460831(97), 460829(97), 440101(95), 460853(07)	Connectors
7	470212(01), 470218(01), 471250(06), 471260(07)	WarmUp

The number in parenthesis is year for introduction of CE mark. Where products are marked with 3 or 4 digits then these are the final numbers in the article numbers above.
 *Marked as 801-2 on the product. ** Marked as 460820 on the product
 #Marked as 460801 on the product

Are in conformity with the following directives
Low Voltage Directive 73/23/EEC (amended in 93/68/ECC)
EMC Directive 89/336/EEC (amended in 93/31/EEC and 93/68/EEC)
 and are built and tested according to the following European norms (where applicable, as indicated by the appliance category to the right)

EN 50066-1	Mini-couplers for mains supplied equipment in road vehicles	5,6,7
EN 50081-1	Generic Emission Standard	2,3,4,7
EN 50082-1	Generic Immunity Standard	3,4,7
EN 60309-1	Couplers for industrial purposes	5,7
EN 60335-1	Household Appliances	1,2,3,7
EN 60335-2-29	Battery chargers	3,7
EN 60335-2-30	Room heaters	2,7
EN 300220-3	Harmonized EN covering essential requirements under article 3.2 of the R&TTE Directive.	4a
EN 301489-3 v. 1-4-1	Specific conditions for Short-Range Devices (SRD) operating on frequencies between 9 kHz and 40 GHz.	4a
EN 301489-1 v. 1.6.1	Electromagnetic compatibility and Radio Spectrum Matters (ERM); ElectroMagnetic Compatibility (EMC) standard for radio equipment and services; Part 1: Common technical requirements.	4a
EN 61000-4-2	Electrostatic discharge	4a
EN 61000-4-3	RF electromagnetic field	4a
ISO 7637-2	Voltage transients, immunity	4a
ISO 7637-2	Voltage transients, emission	4a

Manufacturer:

Place and Date: Nesbyen 22/08/2007	Signature: 	Name/Position: Morten Berg President Automotive Division
--	---	---

Main office: DEFA AS Blingsmøvtun 30 3540 Nesbyen NORWAY	Phone: +47 32 06 77 00 Fax : +47 32 06 77 01	Branch office DEFA AS P.b 370 1301 Sandvika NORWAY
		Phone: +47 32 06 77 00 Fax: +47 67 80 46 01

CE - Declaration



ISO/TS 16949:2002

Systems Certification

Certificate of Registration

The following organization's quality management system has been assessed and registered by Intertek Testing Services NA, Inc. as conforming to the requirements of:

ISO/TS 16949:2002

Organization:
DEFA AS
 Blingsmoveien 30, N-3540, Nesbyen, Norway

The Quality Management System is applicable to:
 Design and Manufacture of Engine Heaters

Having been audited in accordance with the "Rules for registration scheme for ISO/TS 16949:2002 Second Edition,"
 Permissible exclusions include: None
 NACE Code: DL, 31, DM 34 SIC Code: 36, 37

In the issuance of this certificate, Intertek assumes no liability to any party other than to the Client, and then only in accordance with the Certification Agreement.

Certificate Number
2008-0090

IATF Certificate Number
0072084

Initial Certification Date
October 23, 2008

Certificate Issue Date
October 23, 2008

Certificate Expiry Date
October 22, 2011

Intertek Testing Services NA, Inc. - 1700 E...

ISO 14001:2004

ISO 9001:2000



Certificate of Registration

The following organization's Quality Management System has been assessed and registered by SEMKO Certification AB as conforming to the requirements of:

ISO 9001:2000

The conditions and extent of this certificate are stated in the certification decision

Defa AS
 Nesbyen, Sandvika

The Quality Management System is applicable to:
 Development, manufacturing, marketing and sales of Car preheating systems, alarm systems, light fittings, electrical outlets and die-casting of aluminium components.

In the issuance of this certificate, SEMKO Certification AB assumes no liability to any party other than to the Client, and then only in accordance with the Certification Agreement.

Certificate Number
34425

Initial Certification Date
8 December 1999

Certificate Issue Date
9 October 2008

Certificate Expiry Date
17 October 2010

SEMKO Certification AB -
P.O. Box 1103, S-164 22 Kieta, Sweden



Certificate of Registration

The following organization's Environmental Management System has been assessed and registered by SEMKO Certification AB as conforming to the requirements of:

ISO 14001:2004

The conditions and extent of this certificate are stated in the certification decision

Defa AS
 Nesbyen, Sandvika

The Environmental Management System is applicable to the management of the environmental aspects related to:
 Development, manufacturing, marketing and sales of Car preheating systems, alarm systems, light fittings, electrical outlets and die-casting of aluminium components.

In the issuance of this certificate, SEMKO Certification AB assumes no liability to any party other than to the Client, and then only in accordance with the Certification Agreement.

Certificate Number
1423118

Initial Certification Date
18 August 2009

Certificate Issue Date
9 October 2008

Certificate Expiry Date
17 October 2010

SEMKO Certification AB -
P.O. Box 1103, S-164 22 Kieta, Sweden

4 - Support



4.8 DEFA web portal - www.defa.com

Upon entering our website, the first thing you will see is the portal **D25** to our user pages. The menu at the top contains links and there is an image menu on the right.

Top menu - This menu leads to a variety of information about our company, mailing addresses, the history of DEFA and our company philosophy. In addition, job postings are also displayed on these pages.

Image menu - On the right-hand side of the page you will see 8 images, which are consumer links to information about all DEFA products. DEFA WarmUp is the uppermost image on the left.

Language

The language can be selected after a selection is made in **D25**. Available languages are displayed in the top menu

Where can I find an engine heater or a vehicle?

Information about engine heaters for your vehicle can be found under "DEALER INFO" in the menu at the top of the **D25** screen under the option "DEFA WarmUp". From there, you will be guided to the **D26** screen.

Proceed as follows:

1. www.defa.com - **D25** screen is displayed.
2. From this screen, select "DEALER INFO" and click on "DEFA WarmUp". From there, you will be guided to the **D26** screen.
3. Select your language from the top menu under "Language".
4. On the left-hand side all the way down at the bottom, you can choose whether you want to search for an engine heater by vehicle, or vehicle by engine heater.

Opt. 1.

Select your vehicle and model in the drop-down menu. A table with your vehicle/model will be displayed in a superimposed menu. (Assuming an engine heater is available.)

The installation manual is available in the table as a PDF.

Opt. 2.

If you already have an engine heater and you would like to know which vehicles it is suitable for, enter the last 3 or 4 digits of the item number for your heater. The article numbers for heaters have six digits. If the number starts with **411XXX**, enter the last 3 digits. If the article number starts with **412** or **413**, the last 4 digits will need to be entered.

At the lower left-hand side of the screen, you can search for vehicles for which a DEFA mounting kit is available.

D25



D25 - DEFA web portal.

On the right-hand side of this page, you will find links to consumer information about our products.

The language is not selected from this page, but rather from the next page presented after a link is selected. You can alternate between the consumer pages and the professional pages D26

D26

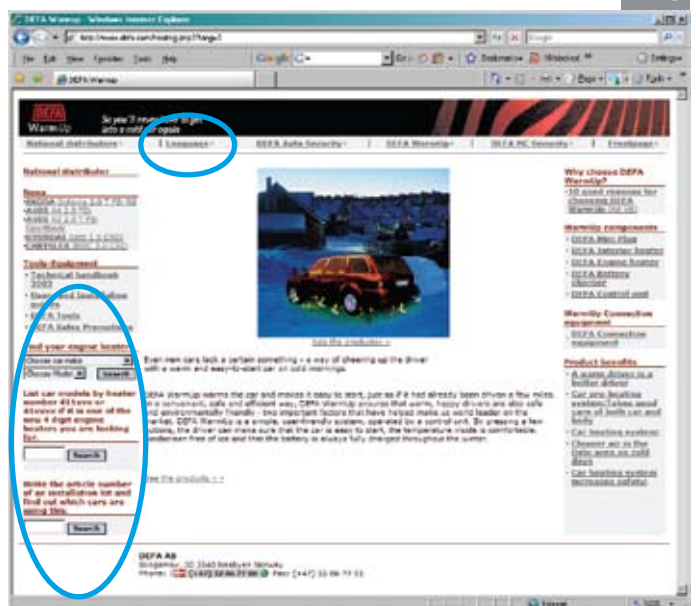

D26 - DEFA professional pages

You will always find a current model list on this page. (New vehicles will be listed as soon as a solution is available.)

Here you will also find all installation manuals and miscellaneous technical documentation.